

**Executive Order 12866**

This regulatory amendment has been reviewed by the Office of Management and Budget under the provisions of Executive Order 12866.

**List of Subjects in 38 CFR Parts 19 and 20**

Administrative practice and procedure, Claims, Veterans.

Approved: May 3, 2004.

**Anthony J. Principi,**  
*Secretary of Veterans Affairs.*

■ For the reasons set out in the preamble, 38 CFR parts 19 and 20 are amended as set forth below:

**PART 19—BOARD OF VETERANS' APPEALS: APPEALS REGULATIONS**

■ 1. The authority citation for part 19 continues to read as follows:

**Authority:** 38 U.S.C. 501(a), unless otherwise noted.

**Subpart A—Operation of the Board of Veterans' Appeals**

■ 2. Section 19.9 is amended by revising the section heading and paragraphs (a) and (b) to read as follows:

**§ 19.9 Remand for further development.**

(a) *General.* If further evidence, clarification of the evidence, correction of a procedural defect, or any other action is essential for a proper appellate decision, a Veterans Law Judge or panel of Veterans Law Judges shall remand the case to the agency of original jurisdiction, specifying the action to be undertaken.

(b) *Exceptions.* A remand to the agency of original jurisdiction is not necessary for the purposes of:

(1) Clarifying a procedural matter before the Board, including the appellant's choice of representative before the Board, the issues on appeal, or requests for a hearing before the Board;

(2) Consideration of an appeal, in accordance with § 20.903(b) of this chapter, with respect to law not already considered by the agency of original jurisdiction. This includes, but is not limited to, statutes, regulations, and court decisions; or

(3) Reviewing additional evidence received by the Board, if, pursuant to § 20.1304(c) of this chapter, the appellant or the appellant's representative waives the right to initial consideration by the agency of original jurisdiction, or if the Board determines that the benefit or benefits to which the evidence relates may be fully allowed on appeal.

\* \* \* \* \*

**Subpart B—Appeals Processing by Agency of Original Jurisdiction**

**§ 19.38 [Amended]**

■ 3. Section 19.38 is amended by removing "the Board and" from the third sentence.

**PART 20—BOARD OF VETERANS' APPEALS: RULES OF PRACTICE**

■ 4. The authority citation for part 20 continues to read as follows:

**Authority:** 38 U.S.C. 501(a) and as noted in specific sections.

■ 5. Section 20.3 is amended by revising paragraph (a) to read as follows:

**§ 20.3 Rule 3. Definitions.**

\* \* \* \* \*

(a) *Agency of original jurisdiction* means the Department of Veterans Affairs activity or administration, that is, the Veterans Benefits Administration, Veterans Health Administration, or National Cemetery Administration, that made the initial determination on a claim.

\* \* \* \* \*

■ 6. Section 20.903 is amended by:

■ a. Revising the second sentence in paragraph (a);

■ b. Removing paragraph (b);

■ c. Redesignating paragraph (c) as paragraph (b); and

■ d. Revising the first sentence in newly redesignated paragraph (b).

The revisions read as follows:

**§ 20.903 Rule 903. Notification of evidence secured and law to be considered by the Board and opportunity for response.**

(a) \* \* \* When the Board receives the opinion, it will furnish a copy of the opinion to the appellant, subject to the limitations provided in 38 U.S.C. 5701(b)(1), and to the appellant's representative, if any. \* \* \*

(b) \* \* \* If, pursuant to § 19.9(b)(2) of this chapter, the Board intends to consider law not already considered by the agency of original jurisdiction and such consideration could result in denial of the appeal, the Board will notify the appellant and his or her representative, if any, of its intent to do so and that such consideration in the first instance by the Board could result in denial of the appeal. \* \* \*

■ 7. Section 20.1304 is amended by:

■ a. In paragraphs (a) and (b)(1)(ii), removing "paragraph (c)" from each, and adding, in each place, "paragraph (d)".

■ b. In paragraph (b)(2), removing "paragraph (b) or (c)" each place it appears, and adding, in each place, "paragraph (a) or (b)".

■ c. Redesignating paragraph (c) as paragraph (d).

■ d. Adding new paragraph (c).

■ e. In newly designated paragraph (d), adding a new sentence immediately after "additional evidence in rebuttal."

The additions read as follows:

**§ 20.1304 Rule 1304. Request for change in representation, request for personal hearing, or submission of additional evidence following certification of an appeal to the Board of Veterans' Appeals.**

\* \* \* \* \*

(c) *Consideration of additional evidence by the Board or by the agency of original jurisdiction.* Any pertinent evidence submitted by the appellant or representative which is accepted by the Board under the provisions of this section, or is submitted by the appellant or representative in response to a § 20.903 of this part, notification, as well as any such evidence referred to the Board by the agency of original jurisdiction under § 19.37(b) of this chapter, must be referred to the agency of original jurisdiction for review, unless this procedural right is waived by the appellant or representative, or unless the Board determines that the benefit or benefits to which the evidence relates may be fully allowed on appeal without such referral. Such a waiver must be in writing or, if a hearing on appeal is conducted, the waiver must be formally and clearly entered on the record orally at the time of the hearing. Evidence is not pertinent if it does not relate to or have a bearing on the appellate issue or issues.

(d) \* \* \* For matters over which the Board does not have original jurisdiction, a waiver of initial agency of original jurisdiction consideration of pertinent additional evidence received by the Board must be obtained from each claimant in accordance with paragraph (c) of this section. \* \* \*

[FR Doc. 04-19693 Filed 9-2-04; 8:45 am]

BILLING CODE 8320-01-P

**POSTAL SERVICE**

**39 CFR Part 111**

**Standards Governing the Design of Wall-Mounted Centralized Mail Receptacles**

**AGENCY:** Postal Service.

**ACTION:** Final rule.

**SUMMARY:** This final rule replaces United States Postal Service® (USPS®) Standard 4B, *Receptacles, Apartment House, Mail*, which governs the design of wall-mounted centralized mail receptacles whether utilized in commercial, residential, mixed

residential or other types of structures. The new standard was developed through a consensus process and was agreed to by a committee of representatives from mailbox manufacturers; mailbox distributors; mailbox installers and servicers; Postal Service customers; multi-unit residential and commercial property builders, owners, and managers; and the Postal Service™. In addition, *Domestic Mail Manual* (DMM™) standards provide manufacturers and customers with notice of the specifications.

**EFFECTIVE DATE:** October 4, 2004.

**FOR FURTHER INFORMATION CONTACT:** Stephen A. Landi, (202) 268-2198.

**SUPPLEMENTARY INFORMATION:** As justification for changes to Standard 4B, the Postal Service presented the committee with evidence of changing customer mailing habits and specific mail and package volume trends. Postal Service statistics indicate customers receive more mail and of varying sizes today than at the time of the last updated standard. A new standard would provide designed receptacles with increased protection for the mail, benefiting both senders and addressees; would improve the overall safety of the equipment in use; should reduce maintenance costs incurred by buildings; and would result in cleaner lobbies with less clutter. Finally, the newly designed receptacle would be easier to access and serve by carriers, thereby helping to reduce Postal Service costs.

In a proposed rule published in the **Federal Register** on April 21, 2004 [69 FR 21455], the Postal Service proposed to replace United States Postal Service Standard 4B, *Receptacles, Apartment House, Mail*, with a new standard, designated United States Postal Service Standard 4C, *Wall-Mounted Centralized Mail Receptacles*. The proposal also included new provisions in the *Domestic Mail Manual* (DMM) to provide manufacturers and customers notice of the new standard. The Postal Service received four comments. After thorough consideration of the issues raised in these comments, and for the reasons discussed below, the Postal Service adopts the rules as proposed.

As discussed in the proposal, a Postal Service Apartment Mailbox Consensus Committee, which included representatives of mailbox manufacturers; mailbox distributors; mailbox installers and servicers; Postal Service customers; multi-unit residential and commercial property builders, owners, and managers; and the Postal Service, developed the new standard through a consensus process.

The members of the committee met six times as an advisory group and negotiated among themselves and with the Postal Service to reach a consensus on a new standard. Committee members were selected for the purpose of, and accepted the responsibility for, representing other interested individuals and organizations that were not present at committee meetings and to keep them informed of the committee's proceedings. As part of the consensus process, the Postal Service agreed to use a recommendation by the committee as the basis of the revised standard.

Standard 4C represents the committee's recommendation. With one exception, each member of the committee signed the final agreement recommending adoption of this standard. That one committee member, a builders association, though supportive of the process and generally in concurrence with the new standard, declined to sign the agreement because a provision of the adopted standard establishes a minimum ratio of parcel lockers to customer compartments. This committee member stated its concerns in a comment submitted on the proposed rule, which the Postal Service will address with the other comments received.

The current standard, adopted in 1975, prescribes design limitations that are no longer consistent with the operational requirements of the Postal Service. The revised Standard 4C is consistent with the day-to-day use of the mail by Postal Service customers, addresses the operational needs of the Postal Service, and provides security for mail through improved design of the equipment. The previous standard was entitled *United States Postal Service Standard 4B, Receptacles, Apartment House, Mail*. The revised standard is entitled *United States Postal Standard 4C, Wall-Mounted Centralized Mail Receptacles*. The Postal Service made the change in the title solely to reflect that the standard applies to receptacles in a variety of residential and commercial buildings, and not only "apartments." The final rule does not result in any change in Postal Service policies concerning the purchase of this delivery equipment or the provision of delivery equipment for Postal Service customers previously in effect under Standard 4B.

The new standard does the following:

1. Creates a new form factor and increases the minimum size requirement to 12" w × 15" d × 3" h.
2. Introduces 12 suggested design types. **Note:** The allowable design types are not limited to these 12, which we

present only as possible compartment configurations.

3. Eliminates the vertical form factor (5" w × 6" d × 15" h) design. The letter carrier delivers mail into the receptacle through the top of the receptacle down into the customer compartment.

4. Introduces a parcel locker requirement based on a 1:10 parcel locker to customer compartment ratio.

5. Strengthens security requirements for the entire receptacle.

6. Standardizes and improves tenant compartment customer lock design.

7. Adds testing requirements to verify acceptability for either indoor or outdoor use.

8. Incorporates a preliminary review by Postal Service engineers intended to identify design discrepancies before manufacturers build prototypes and make tooling investments.

9. Allows manufacturers to submit their designs to approved independent laboratories for initial environmental and functional testing. The Postal Service will perform security tests.

10. Introduces quality management systems provisions.

11. Enhances design flexibility for concept, ergonomics, and materials.

12. Meets Americans with Disabilities Act (ADA) standards.

13. Provides a progressive phase-in period to allow consumers to become aware of the new standard and include it in development plans.

#### Analysis of Comments

The Postal Service received four comments in response to the proposal. Two commenters, a building material supplier and a trade association of builders that was a member of the consensus committee, submitted comments.

The two individual commenters expressed a concern that the committee did not include any party representing the interests of individual apartment residents. However, in establishing the committee, the Postal Service attempted to assure representation of all interests. Before the selection of the committee, the Postal Service chose a facilitator who attempted to identify all interests and secure a suitable representative for each. The Postal Service also published a notice in the **Federal Register** and other publications announcing its intention to revise this mailbox standard, employing a negotiated rulemaking process, and identifying those whom it planned to invite. The notice encouraged any member of the public who believed he/she was not adequately represented to seek committee membership. The Postal Service received no applications by

representatives from the "general public". After the committee convened, the Postal Service and the committee facilitator continued to seek out representatives of apartment and condominium dwellers. Some apartment and condominium residents attended meetings and participated actively, but chose not to serve as committee members. Further, the Postal Service ensured that all committee meetings were open to the public, and that every individual who expressed any interest in wall-mounted centralized mail receptacles received notice of meetings and copies of all relevant documents in advance.

Moreover, even though none of the committee members directly represented apartment residents, members shared some of the substantive concerns expressed by the individual commenters. For example, building managers, owners, and builders shared the concern for affordable receptacles; and Postal Service customers shared the concern that the receptacles should be secure and large enough to allow mail delivery without damage.

Two commenters noted issues with retrofitting; *i.e.* replacement of receptacles that met the specifications in effect at the time of their installation with receptacles that meet the specifications in Standard 4C. The committee discussed retrofitting at length from the first meeting until near the midpoint of the meetings, at which time members reached consensus on how to address retrofitting concerns. These discussions generally contrasted the benefits of retrofitting against the costs of purchasing new receptacles and, in some cases, making structural alterations necessary to accommodate those boxes. Committee members also raised concerns involving building codes, waivers, historical buildings, and objective standards that might trigger a retrofitting requirement. The committee agreed that building owners and property managers might retrofit voluntarily; and that such voluntary retrofits might be encouraged. However, the new standard imposes no general retrofit requirement.

One commenter raised the concern that Postal Service officials might allow the use of non-Postal Service-approved mail receptacles. However, the standard did not change the general and longstanding requirement that, in order to receive delivery service, the Postal Service must approve the delivery equipment provided by the customer.

One commenter objected to the requirement that parcel lockers be provided. It questioned the Postal Service's authority to require the

installation of these receptacles and asserted the opinion that this requirement would give the Postal Service an advantage over other parcel delivery companies that cannot require buildings to provide such receptacles.

The Postal Service does not, of course, require its customers to provide receptacles. Rather, it establishes the type of equipment that customers, including multi-unit residential and commercial structures, must provide if they wish to receive postal delivery service. Moreover, the new standard does not invariably require the installation of parcel lockers when receptacles meeting the requirements of Standard 4C are installed. There are certain buildings that will be exempt from the requirement (*i.e.*, buildings with relatively few units). Moreover, to be exempt from the requirement, buildings may provide an alternative procedure for delivery of parcels.

The parcel locker requirement is consistent with the Postal Service's statutory responsibility to provide an efficient system for the delivery and collection of mail (39 U.S.C. 403(b)(1)). Although the receptacles are commonly called "parcel lockers," the Postal Service will use them for more than the delivery of parcels. For example, for delivering mail held pursuant to a customer's request during the period while a customer is absent, and for periodically delivering mail to customers whose volume exceeds the size of their assigned receptacle. Accordingly, they will be used for a broader variety of matter than that generally delivered by parcel delivery companies and will save the Postal Service the time and expense needed to attempt redelivery of mail, and customers the time and expense of trips to a Postal Service facility to retrieve mail that could not be delivered.

However, even if the parcel lockers were only used for parcels, the adoption of the parcel locker requirement would be fair. The commenter observed that the cost of the receptacles will ultimately be passed on by building owners to residents. Therefore, the residents would ultimately bear the costs of their mail delivery, which also seems fair. The alternative would be that the Postal Service incur the costs and pass them on to all customers, through postal rates, even though they may not be residents of multi-unit structures. Parcel delivery companies would also pass their costs on, through the rates they charge, to the specific customers that use their services rather than to all residents of the country.

Two commenters raised as an issue the changes in the size of the customer

compartment, coupled with the parcel locker requirement, and the resulting increase in the "footprint" for the equipment. The committee recognized that increased size would present challenges and create pressures on lobby size, architectural design, industry education, and construction costs. The committee debated these factors and reached compromises that address those concerns by allowing buildings currently under design, as well as buildings just beginning construction, time for approval of plans without requiring modifications. The committee established a timeline for mandatory compliance in new construction, at 2 years from the publication of the final rule. This timeline allows committee members and the Postal Service time to educate the public and members and employees of their respective organizations of the provisions of the Standard 4C.

Moreover, as briefly noted above, the standard does not require parcel lockers in buildings with less than 10 customer compartments, and establishes the parcel locker to customer compartment ratio at 1:10 in buildings with more than 10 customer compartments. The standard provides that postmasters shall consider and may excuse buildings from the need to provide parcel lockers if they have an agreement in place with the building owners or property managers that establishes an alternate parcel delivery service (*e.g.*, concierge service or acceptance at the building management office). The standard allows flexibility in the location of parcel lockers (subject to local approval) if not fully integrated in the mail receptacle or if located adjacent to customer compartments. The standard also recognizes that some commercial and residential buildings provide receptacles for tenants that exceed the minimum size requirements and can accommodate parcels.

Commenters also addressed the potentially increased cost of new receptacles to property owners/managers and the possibility of property owners/managers passing these cost increases on to their tenants. The committee included manufacturers of apartment mailboxes who estimated increases in cost for materials, components, and tooling would vary between 15 and 30 percent over current costs depending on many factors including the size and abilities of the manufacturer, the materials and components they use to manufacture mail receptacles, and market conditions. One commenter questioned whether these estimates were accurate, although

it did not provide any information suggesting the estimates are inaccurate. Another commenter alleged that the costs might increase by a factor of "ten to twelve times," questioning whether the resultant costs were worth the benefits that would result from the new standards, but did not provide evidence to support its cost estimates. The Postal Service does not have any basis to believe the committee's cost estimates understate the future price increases for receptacles meeting the Standard 4C requirements, and believes the benefits will justify the changes.

One commenter questioned the need for upgraded security for delivery equipment. This commenter felt the security level of current boxes was sufficient, a position not supported by the committee nor the Postal Service. USPS Engineering and the Postal Inspection Service demonstrated that better equipment would improve the security of personal information from identity theft. They provided historical documentation of mail theft and demonstrated proven methods of attacks on mail equipment. From 2000 to 2002, Inspection Service statistics indicate that reported attacks on wall-mounted boxes increased from 988 in FY 2000 to 2,819 in FY 2002. While it is not economically feasible to require equipment that will protect receptacles against all potential attacks, this final rule provides equipment that will increase mail security and help to reduce the incidences of theft. This effort is consistent with other ongoing Postal Service initiatives to improve mail security and customer ease of use in mail delivery equipment.

A commenter also asked whether the Postal Service would supply these receptacles to customers and whether there would be more than two authorized suppliers. As explained above, this rulemaking will not result in any changes in Postal Service policies concerning the provision of delivery equipment. Rather, owners/managers of multi-unit buildings will remain responsible for the provision of wall-mounted centralized mail receptacles required for delivery service. Moreover, the rule does not establish any limit on the number of manufacturers authorized to manufacture and distribute receptacles meeting the specifications of Standard 4C; any manufacturers (currently six) that meet the specifications may apply for and receive an authorization to produce and distribute such boxes.

#### Approval Process for Receptacles

In order to be eligible for Postal Service carrier mail delivery, the Postal

Service must approve the boxes. In order to receive approval under Standard 4C, the manufacturer must submit the receptacle(s), along with the supporting materials listed in section 6 of the standard, to the Postal Service at the following address:

Attn: Delivery and Retail Systems, USPS Engineering, 8403 Lee Hwy, Merrifield Va 22082-8101.

#### Re-Approval of Standard Receptacles, Apartment House, Mail USPS STD 4B+

The re-approval process for manufacturers with mailbox designs that were approved before the final publication date of Standard 4C will be conducted as follows: (The approval process for all other wall-mounted receptacle designs will be conducted in accordance with section 6 of Standard 4C.)

1. The Postal Service will permit, for 180 days after publication in the **Federal Register** of the final rule, current Postal Service Standard 4B-approved equipment for new installations or as replacement for existing boxes. After the 180-day period has elapsed, the Postal Service will no longer authorize the distribution and installation of equipment approved under Standard 4B or install Arrow locks in this equipment.

2. Only manufacturers with current, Postal Service-approved Standard 4B designs may submit design and product for recertification to Standard 4B+.

3. The Postal Service will notify currently approved manufacturers within two (2) business days after final publication of Standard 4C in the **Federal Register** that they may submit their equipment for recertification. The Postal Service will provide a copy of Standard 4B+ Change Notice #2, which outlines the Standard 4B+ requirements. All equipment must be submitted to: Attn: Delivery and Retail Systems, USPS Engineering, 8403 Lee Highway, Merrifield, Va 22082-8101.

4. Manufacturers will have 60 days after receipt of this notification to submit a written response to USPS Engineering of their intent to submit equipment for recertification to Standard 4B+.

5. Manufacturers who have properly notified the Postal Service of their intent to manufacture equipment to Standard 4B+ under step 4 have 365 days from the date of publication of the final rule to gain the necessary approval for the receptacle under Standard 4B+. However, a vendor may not make an additional submission until it has received a decision from the Postal Service on a pending submission. A vendor may make unlimited

submissions within the 365-day period. USPS Engineering will respond to each submittal within 45 days.

6. A previously approved vendor must submit written notification within the 60-day period to manufacture and distribute equipment that meets Standard 4B+ requirements. However, the vendor may elect to submit equipment for approval to the requirements set forth in section 6 of Standard 4C.

#### List of Subjects in 39 CFR Part 111

Postal Service.

#### PART 111—[AMENDED]

■ 1. The authority citation for 39 CFR part 111 continues to read as follows:

**Authority:** 5 U.S.C. § 552(a), 39 U.S.C. §§ 101, 401, 403, 404, 3001-3011, 3201-3219, 3403-3406, 3621, 3626, 5001.

■ 2. Revise the *Domestic Mail Manual* (DMM) as follows:

#### Domestic Mail Manual (DMM)

\* \* \* \* \*

#### D Deposit, Collection, and Delivery

##### D000 Basic Information

\* \* \* \* \*

##### D040 Delivery of Mail

##### D041 Customer Mail Receptacles

[Add new section 3.0, to read as follows]

#### 3.0 WALL-MOUNTED CENTRALIZED MAIL RECEPTACLES

##### 3.1 Manufacturer Requirements

Manufacturers of wall-mounted centralized mail receptacles used for mail delivery must receive approval under the specifications and procedures set forth in USPS Standard 4. The specifications and other applicable information can be obtained by writing to USPS Engineering (*see* G043 for address) or from [wallmountedreceptacles@usps.gov](mailto:wallmountedreceptacles@usps.gov).

##### 3.2 Customer Requirements

The installation of proper equipment is required for the provision of delivery service. The type of equipment must be approved by the Postal Service under 3.1 and must be appropriate for the structure. Customers should discuss the types of approved equipment permitted for their structures with their postmaster before purchasing and installing delivery equipment. Additional information is available at [wallmountedreceptacles@usps.gov](mailto:wallmountedreceptacles@usps.gov).

\* \* \* \* \*

■ 3. Replace USPS-STD-4B with USPS-STD-4C as set forth below:

## U.S. Postal Service Standard Wall-Mounted Centralized Mail Receptacles

### 1. Scope

1.1 *Scope*—This standard covers the design, testing, and acceptance of wall-mounted, centralized mail receptacles. The use of this standard is mandatory and the receptacles shall conform to this standard in order to be approved by the Postal Service™.

1.2 *Suggested Design Types*—Wall-mounted, centralized mail receptacles may be of the general types as shown in figures 1 through 12. The depicted representations are only examples of possible compartment configurations. The intention of these figures is not to dictate specific designs and compartment arrangements, but to portray design examples that meet the requirements. In all cases, the units shall be designed for fully recessed wall mounting.

Type I, Front Loader—A family of mail receptacles in a single column configuration with a single master door design, a minimum of 3 and a maximum of 8 customer compartments, 1 mail collection compartment with separate outgoing mail slot and Arrow lock door, and 1 parcel compartment.

Type II, Front Loader—A family of mail receptacles in a double column configuration with a double master door design, a minimum of 3 and a maximum of 16 customer compartments, 1 mail collection compartment with separate outgoing mail slot and Arrow lock door, and 1 or 2 parcel compartments.

Type III, Front Loader—A family of mail receptacles in a double column configuration with a single master door design, a minimum of 3 and a maximum of 16 customer compartments, 1 mail collection compartment with separate outgoing mail slot and Arrow lock door, and 1 or 2 parcel compartments.

Type IV, Rear Loader—A family of mail receptacles in a single column configuration with a rear access cover design, a minimum of 3 and a maximum of 8 customer compartments, 1 mail collection compartment, and 1 parcel compartment.

Type V, Rear Loader—A family of mail receptacles in a double column configuration with a rear access cover design, a minimum of 3 and a maximum of 16 customer compartments, 1 mail collection compartment, and 1 or 2 parcel compartments.

Type VI, Front Loader (No Parcel Compartment)—A family of mail receptacles in a single column configuration with a single master door design, a minimum of 3 and a maximum of 9 customer compartments and 1 mail

collection compartment with separate outgoing mail slot and Arrow lock door.

Type VII, Rear Loader (No Parcel Compartment)—A family of mail receptacles in a single column configuration with a rear access cover design, a minimum of 3 and a maximum of 9 customer compartments, and 1 mail collection compartment.

Type VIII, Front Loader (No Parcel Compartment)—A family of mail receptacles in a double column configuration with a double master door design, a minimum of 3 and a maximum of 19 customer compartments, and 1 mail collection compartment with separate outgoing mail slot and Arrow lock door.

Type IX, Rear Loader (No Parcel Compartment)—A family of mail receptacles in a double column configuration with a rear access cover design, a minimum of 3 and a maximum of 19 customer compartments, and 1 mail collection compartment.

Type X, Front Loader, Parcel Only (No Master Door)—A family of parcel receptacles in a single column configuration without a master door design. These units are designed to provide separate parcel delivery capability for wall-mounted centralized mail receptacles installed without integral parcel compartments.

Type XI, Front Loader, Parcel Only—A family of parcel receptacles in a single column configuration with a master door design. These units are designed to provide separate parcel delivery capability for wall-mounted, centralized mail receptacles installed without integral parcel compartments.

Type XII, Rear Loader, Parcel Only—A family of parcel receptacles in a single column configuration with a rear access cover design. These units are designed to provide separate parcel delivery capability for wall-mounted, centralized mail receptacles installed without integral parcel compartments.

1.3 *Approved Manufacturers*—A list of approved manufacturers is available upon request from: USPS Engineering, Delivery and Retail Systems, 8403 Lee Highway, Merrifield Va 22082-8101.

1.3.1 *Interested Manufacturers*—Manufacturers interested in selling wall-mounted, centralized mail receptacles to the public are required to obtain Postal Service approval. See section 6 for the application process.

### 2. Applicable Documents

2.1 *Specifications and Standards*—Except where specifically noted, the specifications set forth herein shall apply to all receptacle designs.

2.2 *Government Documents*—The following documents of the latest issue

are incorporated by reference as part of this standard.

*United States Postal Service*—POM, *Postal Operations Manual*

Copies of the applicable sections of the Postal Operations Manual can be obtained from USPS Delivery and Retail, 475 L'Enfant Plaza SW, Washington, D.C. 20260-6200.

USPS-L-1172—Locks, Compartment, Customer—PSIN O910

Copies of United States Postal Service® specifications, standards and drawings may be obtained from USPS Delivery and Industrial Equipment CMC, Greensboro, NC 27498-0001.

2.3 *Non-Government Documents*—The following documents of the latest issue are incorporated by reference as part of this standard.

*STANDARDS*—*American Society for Testing and Materials (ASTM)*

ASTM G85 Standard Practice for Modified Salt Spray (Fog) Testing  
ASTM D968 Standard Test Methods for Abrasion Resistance of Organic Coatings by Falling Sand  
ASTM D3801 Standard Test Methods for Measuring the Comparative Burning Characteristics of Solid Plastics in a Vertical Position

Copies of the preceding documents may be obtained from the American Society for Testing and Materials, 100 Barr Harbor, West Conshohocken, PA 19428-2959. (<http://www.astm.org>)  
*Underwriters Laboratories*—UL 771,

Night Depositories (Rain Test Only)

Copies of the preceding document can be obtained from Underwriters Laboratories Inc., 333 Pfingsten Road, Northbrook, IL 60062-2096. (<http://www.ul.com>)

### 3. Requirements

3.1 *General Design and Construction*—The general configurations of the wall-mounted, centralized mail receptacles shall conform to the requirements as described in this standard. The receptacles shall be designed and constructed so that they can be serviced according to the intended method, front or rear access. The receptacles shall be designed to allow wall mounting in accordance with the installation requirements as stipulated in this document and the applicable sections of the current *Postal Operations Manual (POM)* as referenced in section 2.2. The receptacle design shall preclude access from one compartment to another and it shall provide the required level of security for all receptacle contents and resistance to vandalism. The clearance between shelving sides and interior sides or rear walls shall prevent the

passage of a 3½-inch (height) by 5-inch (length) by .007-inch thick card from one compartment to another.

The design of all wall-mounted, centralized mail receptacles may be of the Types specified in 1.2. The design of all receptacles shall be such that the unit can be installed either indoors or outdoors. Outdoor installations shall be in compliance with conditions as described in this document and the applicable sections of the POM without damage or deterioration to the materials of the receptacle or to its contents. Each unit shall be made of the exact materials, construction, coating, finish, etc., as shown on the manufacturer's drawings, which are identified and certified by the Postal Service. The overall height, width, and depth of any receptacle shall be such that all the applicable mounting requirements shall be met.

All front loading receptacles shall have fixed solid backs.

3.2 *Materials*—Latitude shall be allowed in the materials used. The thickness, form, and mechanical and chemical properties of the material shall be adequate to meet the operational, structural, and performance requirements set forth in this standard. Materials must be compatible with each other; nontoxic and nonirritating to humans. Dissimilar metals shall be protected against galvanic corrosion. The material used in the fabrication of this equipment shall be new, suitable for the purpose used, free from all defects, and of the best commercial quality for this type of equipment.

3.3 *Colors, Coatings and Finishes*—Exterior colors and finishes of the receptacles, in general, shall be optional with the manufacturer. Any finish or coating selected should meet all the requirements of this document.

3.4 *Mounting and Hardware*—The hardware for attaching the receptacle to the wall shall be provided and packaged with the unit. All mounting hardware shall meet the corrosion resistance requirements of this document. Mounting hardware shall not protrude from any part of the unit to create a hazardous catch or bump point for customers or carriers. The mounting hardware shall be accessible for replacement in the event of damage to the unit and shall be hidden from public view while in service. The mounting technique and hardware selected shall allow the receptacle, when wall-mounted in accordance with the manufacturer's instructions, to meet the pull requirements of section 4.11.9.

3.5 *Customer and Parcel Compartment Doors*—All compartment doors shall meet the common

requirements listed in this section. In addition, each type of compartment doors shall meet any unique door requirements as described in 3.5.1 through 3.5.4 below.

All compartments of front loading receptacles shall have their own door and shall be hinged on the right. The door hinges shall be concealed or designed to prevent tampering. The doors shall be designed to open, close, and lock without binding or excessive play. All doors shall open a minimum of 90 degrees. The clearance between door and door opening shall be evenly spaced, consistent in size, and minimized to preclude prying with such simple tools as knives, screwdrivers, thin metal strips, etc.

Optional compartment heights, requiring doors or blanking plates larger than the minimum, shall be allowable, except as stated in section 3.5.3. However, no offered compartment height shall preclude any of the critical installation requirements, or any other requirement, from being met. In addition, no compartment size shall be offered as "approved" that is larger than any Postal Service tested and approved size for that particular manufacturer.

3.5.1 *Customer Compartment Doors*—Once opened, a customer door shall remain in the opened position until closed and locked. Each door shall permit the mounting of a lock as required by 3.10.1.

3.5.2 *Parcel Compartment Doors*—The doors shall be spring loaded to return the doors to the fully closed position. The spring shall be of sufficient strength to close the door from any opened position. The strength of the spring shall not be excessive as to create the potential for injury or cause the doors to "slam" shut. Each door shall permit the mounting of locks as required by 3.10.2.

3.5.3 *Carrier Access (Arrow Lock) Door (Front Loader Designs)*—The carrier access door shall have accommodations for mounting either Arrow lock shown in figure 13 in such a manner that the modified Arrow lock cylinder is flush with the front of the compartment door and the standard Arrow lock is slightly recessed. This door shall be designed to accommodate the mounting of the Arrow lock and the securing of a minimum-sized (3 inches high by 12 inches wide by 15 inches deep) compartment, which typically shall be used for retrieval of collection mail. For security reasons, under no circumstances shall this door be offered in any larger sizes. Once opened, the carrier access door shall remain in the opened position until closed and

locked. This door shall not be numbered or lettered.

3.5.4 *Collection Mail Compartment Blanking Plate (Rear Loader Designs)*—Rear loader receptacles shall have a blanking plate, sized to cover a minimum 3 inches high by 12 inches wide compartment, directly beneath the collection mail slot. This plate ensures a minimally acceptable compartment volume for the customer outgoing mail on rear loaders.

3.6 *Master Loading Door(s)*

3.6.1 *Front Loader Designs*—These units shall be equipped with a master loading door(s) on the same side as the individual compartment and parcel doors. The master loading door(s) shall allow access to all the unit's customer compartments and parcel compartments for the deposit of letter mail and parcels and the collection of customer outgoing mail. The master loading doors shall be designed not to interfere with the loading of customer and parcel compartments. These doors shall be designed so the withdrawal of mail through the individual customer doors allows the mail to slide smoothly over any parts of the master, customer, or parcel doors. The master loading door(s) shall be easy to open and close. For any double master loading door design, the doors shall be hinged on opposite sides and latched at the center of the unit. The door hinges shall be continuous or concealed and designed to prevent tampering. The doors shall lock in the open position by an automatic self-locking device until the delivery employee completes loading. The doors shall be held open at an angle of 90 degrees (+5, -0). The delivery employee shall be able to easily release the hold open device to close the door when loading has been completed. The door hold-open device shall withstand an inward or outward pull of 50 (+5, -0) pounds when applied to the master door edge farthest from the master door hinge and in a direction perpendicular to the door. (**Note:** For any nonparcel compartment design, disregard parcel compartment references.)

The master loading door for any single door receptacle design and the right master loading door for any double master door design shall, as a minimum, have provisions and accommodations for a three-point (top, middle, bottom) latching mechanism, exclusive of the hinges, in conjunction with either a standard or modified Arrow lock to secure the door. Unless used solely as an actuator for locking pin(s), the Arrow lock shall lock the master loading door latch mechanism to ensure that the master loading doors are securely latched and that the latch mechanism

cannot be moved. A limited loading shall be permitted on the end of the Arrow lock bolt only when the Arrow lock is used as an actuator to engage locking pins. In this case, the locking pin(s) shall secure the Arrow lock door to the master loading door frame. Only Arrow locks dimensioned in figure 13 shall be acceptable. The latching mechanism shall be rigid in design to avoid distortion. Locknuts shall be included for installing the Arrow lock. The master loading door(s) shall be easy to open, close, and lock. The carrier access shall not have pinch points or sharp edges. Clearance between the door and door opening shall be evenly spaced and consistent in size. The master loading doors shall be easily unlatched and opened using one hand. The latch mechanism may be mounted either on the unit frame or the master loading door. Clearance below the latch handle in either case shall be a minimum of 1.25 inches. When the carrier activates a master loading door latch mechanism mounted on the unit frame, the outer edge of the master loading door shall be automatically opened a minimum of 1 inch outside the door frame, enabling the carrier to easily grasp the door. When the latch mechanism is mounted on the unit frame, the handle must provide between 1.25 and 1.50 inches of grip length and a minimum of 1 square inch of surface area. When the carrier activates a master loading door latch mounted on the door, the latch handle may be used to pull the door open. When the latch mechanism is mounted on the door, the handle must provide a minimum of 1.75 inches of grip length. In any double master door design, when the master loading door with the Arrow lock traps, or locks the left master loading door, a push-out device shall not be required if the carrier can easily grasp and open the left door.

**3.6.2 Rear Loader Designs**—The master loading door for any rear loading units shall be in the form of a rear cover or door, which can be opened or removed and closed or replaced by the mail carrier, which will permit delivery of mail to each compartment. The cover or door shall prevent the mail from falling out between the cover or door and shelves, and be strong enough to prevent theft of the contents of adjoining receptacles by manually forcing the rear door or cover from the front of the receptacle through a compartment. The cover or door shall be capable of being latched or secured; locking is not required.

**3.7 Customer and Parcel Compartment Sizes**—Customer and

parcel compartment size requirements shall be as specified below.

**3.7.1 Customer Compartment Sizes**—The minimum interior dimensions of each customer delivery compartment shall be 3 inches high by 12 inches wide by 15 inches deep. Optional compartment heights, greater than the 3 inch minimum, shall be allowable, and mixed size customer compartments may be offered in any one unit. However, no combination shall preclude any of the critical installation requirements, or any other requirement, from being met. In addition, no compartment size shall be offered as “approved” that is larger than any Postal Service-tested and approved size for that particular manufacturer.

**3.7.2 Parcel Compartment Sizes**—The minimum interior dimensions of the parcel compartments shall be as follows:

- (a) Standard Parcel Locker—15 inches high by 12 inches wide by 15 inches deep
- (b) Large Parcel Locker—18 inches high by 12 inches wide by 15 inches deep

**3.7.2.1 Parcel Locker to Customer Compartment Ratio**—A minimum of one standard parcel locker shall be provided for every ten customer compartments. For installation sites with less than ten customer compartments, there shall be no mandatory parcel locker requirement, however, it shall be the intent of the Postal Service to strongly encourage the inclusion of a parcel locker.

**3.8 Collection Mail and Carrier Access (front-loading designs only) Compartment**—All units shall have one reinforced collection mail compartment. A mail deposit slot 10.75 inches wide by .75 inches high shall be provided with a weather shield and a security shield to protect the deposited mail from the rain and snow and to prevent removal of the mail by fishing and pilfering techniques through the deposit slot. This compartment shall not be numbered or lettered. The phrase “OUTGOING MAIL” shall be marked on the deposit slot shield in black, recessed lettering. Marking shall be permanent and lettering size shall be  $\frac{3}{8}$  to  $\frac{1}{2}$  inch high.

**3.8.1 Front-Loading Designs**—For front-loading designs, the front of the minimum-sized collection compartment shall consist of the carrier access (Arrow lock) door, as described in section 3.5.3, and the mail collection/deposit slot, which is framed by separate elements providing the weather and security shielding. The mail deposit slot frame design shall be hard mounted to the master door structure. Optional

outgoing mail compartment heights shall be allowable. Hard-mounted front blanking plates shall be used as required under the Arrow lock door for any larger collection mail compartment offerings. In addition, no offered outgoing mail compartment height shall preclude any of the critical installation requirements, or any other requirement, from being met, and no compartment size shall be offered that is larger than any fully tested size.

**3.8.2 Rear-Loading Designs**—For rear-loading designs, the front of the minimum-sized collection compartment shall consist of a blanking plate hard mounted to the master door structure and the mail collection/deposit slot, which is framed by separate elements providing the weather and security shielding. Optional outgoing mail compartment heights, requiring blanking plates larger than the minimum, shall be allowable. However, no offered outgoing mail compartment height shall preclude any of the critical installation requirements, or any other requirement, from being met. In addition, no compartment size shall be offered that is larger than any fully tested size.

**3.9 Identification**—Customer and compartment identifications shall be in the following manner.

**3.9.1 Customer Compartment Identification**—Customer compartment doors shall be identified using either numbers or letters, optionally, in sequence from top to bottom. For any double master door designs, the numbers or letters shall start from the upper left corner compartment. In addition, they shall be  $\frac{3}{4}$  to 1 inch high, sequential, black, and recessed. They may be engraved or stamped. Brushed aluminum decals with black numbering may be used, provided the decals are recessed in the door or a raised rib is provided around the decal to enhance the decal’s location and limit removal. Decals shall be secured using a permanent type of adhesive. Numbers shall be made with one decal and not a combination of two single letter or number decals. In the horizontal direction, the centerline of the numbers shall be to the right of the customer lock (top lock) centerline. In the vertical direction, the customer lock and the numbers shall be the same centerline.

**3.9.2 Parcel Compartment Identification**—Parcel compartment doors shall be provided with  $\frac{3}{4}$  to 1 inch high, sequential, black, recessed numbers. Numbers may be engraved or stamped. Brushed aluminum decals with black numbering may be used, provided they are recessed in the door or a raised rib is provided around the

decal to enhance decal location and limit removal. Decals shall be secured using a permanent type of adhesive. Numbers shall be made with one decal and not a combination of two single letter or number decals. Raised lettering shall not be acceptable. Parcel compartment doors shall be numbered (typically, 1P, 2P, etc). In the horizontal direction, the centerline of the letters shall be to the right of the customer lock (top lock) centerline. In the vertical direction, the customer lock and the numbers shall be the same centerline.

**3.9.3 Customer Identification**—A minimum 1/2 inch wide surface shall be located below the front of each delivery compartment shelf. The surface shall be concealed by the master door(s) and shall be visible only by the carrier once the master door(s) is opened. The surface provided shall be smooth and will allow for the optional attachment of self-adhesive labels. Alternatively, each compartment may be equipped with either a clasp or holder to accommodate a name card, or supplied with a designated flat surface for a permanent-type pressure-sensitive label for identifying the customer using the compartment. The holder or clasp shall be located on the frame above each compartment or inside of the compartment where the customer's name will be easily visible to the carrier when the box is opened for loading. The holder shall be of sufficient size to hold a name card of .75 inch by 2.50 inches or as large as space permits.

**3.10 Locks**—Locks and cams shall be provided as specified below.

**3.10.1 Customer Compartment Locks**—Each customer compartment door shall use a PSIN O910 lock, as specified in USPS-L-1172, or equivalent. The hole pattern for the lock is shown in figure 14. The hole shall be able to withstand 100 foot pounds of rotational torque, preventing the lock from being turned in the door allowing unauthorized entry into the compartment. The locks shall be oriented so that the locking cam rotates 90 degrees from the locked to the unlocked position. The key shall be removable only in the locked position. Individual customer locks shall be located in the compartment doors on the left side. Each lock shall be provided with three keys as specified in section 3.11.1. Key numbers shall not be placed on any exterior exposed surface. Cams shall be designed by the manufacturer to allow a secure grip of the lock to the compartment side wall. Each compartment lock shall be keyed differently in each receptacle. The locks must be securely fastened to the door to preclude punching out and twisting off.

All customer compartment doors shall be locked for shipment.

**3.10.2 Parcel Compartment Locks**—Each parcel compartment door shall be configured to accept a combination 910/Arrow lock arrangement. The 910 lock shall serve as the customer access lock. Any parcel compartment provided as an integral part of a receptacle design shall have a 910 lock that is keyed differently than any customer compartment lock in the receptacle. The lock may itself provide the locking cam to secure the parcel door or it may be used as an actuator in such a way as its cam moves locking pins into place to secure the parcel door. The locking pins would withstand the pry attack loads. The Arrow lock “captures” the 910 lock after its key has been inserted and the lock turned to allow the customer to remove their parcel. The Arrow lock and the 910 lock shall be located in a partitioned compartment and, for ease of maintenance reasons, shall not share the same compartment cover. The 910 lock cover shall be secured with standard hardware while the Arrow lock compartment cover shall be secured with tamper resistant screws. All parcel compartment doors shall be locked for shipment.

**3.10.3 Master Loading Door Lock (Front-Loading Designs)**—Front loader receptacles shall be secured with an Arrow lock, in accordance with figure 13, to lock the master loading door(s) as defined in section 3.6.1. These units shall be configured so that the Arrow lock is always located directly beneath the collection mail slot. The mail slot and the Arrow lock door (carrier access door) shall share the same compartment but be separate items for security reasons. The Arrow lock shall be furnished and installed by the local postmaster or his representative. In addition, the Postal Service will provide dummy Arrow locks for test purposes upon request.

**3.11 Keys and Key Identification**—All compartment keys for locks in accordance with USPS-L-1172 or equivalent shall be identified and perform in the following manner to allow for efficient control, security, and operation. No two compartments in the same receptacle shall be keyed alike. In addition, the full complement of required key codes shall be utilized in sequential order prior to repeating any individual key code within a production lot of receptacles. All keys shall have any burrs removed and shall move freely in and out of the lock. When the lock is installed and the key is inserted, the locks must be positioned so that the key is free to turn without binding or

contacting/scraping any adjoining surface.

**3.11.1 Compartment Keys**—Three keys shall be provided for each customer compartment and shall be delivered on a single key ring. All keys shall be temporarily identified for their respective compartment, bagged, and securely taped inside the collection compartment for shipping.

**3.11.2 Parcel Keys and Tags**—Heavy-duty, rigid, clear plastic tags with card inserts containing instructions to the Postal Service customer on the use of the key, shall be furnished with each key for an individual parcel receptacle. The plastic tags shall be 1 1/2 ± 1/16 inches wide by 3 ± 1/16 inches long by 1/16 (+1/16, -0) inches thick, and shall have an opening at one end for a key ring. All holes or openings shall be reinforced. The tags shall also have a swivel device for key ring mounting. Heavy-duty rings for attaching the holder to the individual key shall be provided for parcel receptacle keys. The key shall not be easy to remove from the key ring. Each insert card shall be identified with a serial number that is the same as the mail receptacle unit's serial number. The cards shall be numbered (e.g., 1P, 2P, etc) to correspond with their respective parcel receptacles. Card insert lettering shall be legible and of sufficient size and contrast to be easily read. All keys shall move freely in and out of the lock. Three keys shall be provided for each receptacle lock, tagged with the clear plastic holder for their respective receptacle, and placed in the same bag with compartment keys.

The card insert shall be as follows:  
Clear Plastic Holder with card insert (side A & B), YOU HAVE MAIL IN RECEPTACLE # \_\_\_\_\_ \* UNLOCK TOP LOCK AND REMOVE MAIL. KEY REMAINS IN LOCK.

**\*Note:** The manufacturer shall provide the numbers and names as specified above.

**3.12 Marking**—For front-loading designs, there must be two inscriptions centered on the carrier access door: “U.S. MAIL” in a minimum of .50 inch high letters and “APPROVED BY THE POSTMASTER GENERAL” in a minimum of .18 inch high letters. For rear-loading designs, these inscriptions must be centered on the blank panel of the outgoing mail compartment. These inscriptions shall be positioned in a vertical stack with “U.S. Mail” appearing above “APPROVED BY THE POSTMASTER GENERAL.” Markings must be permanent and may be accomplished by applying a decal, embossing on sheet metal, applying raised lettering on plastic, or using other methods that are suitable. In addition, a



legible and permanently marked decal with "USPS-STD-4C," the manufacturer's name, address, date of manufacture (month and year), unit serial number, and model number or nomenclature must be affixed to the receptacle in a location that is readily visible to carriers.

**3.13 Assembly and Installation Instructions**—A complete set of instructions including illustrations for assembling and installing the receptacle shall be prepared and provided with each receptacle. Both front- and rear-loading receptacles shall be mounted in accordance with the installation requirements as stipulated in this document and the applicable sections of the current *Postal Operations Manual* (POM) as referenced in section 2.2. The installation described shall be tested in accordance with the testing of section 4.11.9. These instructions shall completely convey all recess wall-mounting details, including equipment installation height restrictions as provided in the figures and the parcel locker ratio information. In addition, the instruction sheet shall carry a notice that the receptacle met all requirements of the Postal Service standard.

**3.14 Workmanship**—Workmanship shall be of the highest quality throughout. All parts shall be clean, straight, accurately formed and assembled, properly fitted, and uniform in size and shape. Parts shall be free from delaminations, cracks, warpage, bulges, kinks, dents, porosity, voids, lumps, foreign matter, and other defects. Finished or coated surfaces shall be smooth and uniform, and free from soft areas, stain, chips, crazing, and cracks. Seams and connections shall be tight. Welding, riveting, and other joining shall be done in a neat and approved manner. The receptacle shall be free from sharp edges, sharp corners, protruding rivets, and operational features, which might injure or hamper the carrier or customer.

**3.15 Bolted Connections**—Bolts or screws that can be removed in any exposed area shall not be used for joining parts of the receptacle. Sheet metal screws shall not be used in the assembly of the receptacle.

**3.16 Riveted Joints**—Hollow-type eyelets or grommets shall not be used in the fabrication of the receptacle.

**3.17 Welding**—Any type of weld (electric-arc, resistance, gas, etc.) may be used in the fabrication of the receptacle, providing it produces a satisfactory and safe joint and is performed in accordance with applicable best commercial practices.

**3.18 Fabrication and Assembly**—All components and parts shall be

fabricated and assembled to be permanently square and rigid to preclude binding, warping, or misalignment, which may reduce or prevent proper equipment operation or maintenance or may result in a premature failure of any part or component.

#### 4. Testing Requirements

**4.1 Testing Requirements**—Units will be subjected to all applicable testing described herein. A unit that fails to pass any test will be rejected. Testing will be conducted in sequence as listed herein and in table III.

##### 4.2 Capacity

**4.2.1 Customer Compartments**—Customer compartments must meet minimum capacity requirements tested by insertion and removal of a standard test gauge which measures 2<sup>15</sup>/<sub>16</sub> inches high by 11<sup>15</sup>/<sub>16</sub> inches wide by 14<sup>15</sup>/<sub>16</sub> inches deep. The test gauge will be inserted with its 2<sup>15</sup>/<sub>16</sub>-inch dimension aligned in the vertical axis (perpendicular to the compartment floor). The gauge must be capable of easy insertion and removal, and while inserted, allow for the door(s) to be completely closed without interference.

**4.2.2 Collection Mail Compartment**—The collection mail compartment must meet minimum capacity requirements tested by insertion through the mail deposit slot of 48 standard letters (4.00 inches high by 9.50 inches long by .12 inch thick) and 4 Express Mail or Priority Mail envelopes (9.50 inches high by 12.50 inches long by .50 inch thick). Letter and envelope thicknesses shall be achieved by inserting 8.50 inch by 11 inch paper.

**4.2.3 Parcel Compartment**—Parcel compartments must meet minimum capacity requirements tested by insertion and removal of a standard test gauge which measures 14<sup>15</sup>/<sub>16</sub> inches high by 11<sup>15</sup>/<sub>16</sub> inches wide by 14<sup>15</sup>/<sub>16</sub> inches deep. The test gauge will be inserted with a 14<sup>15</sup>/<sub>16</sub> inch dimension aligned on the vertical axis (perpendicular to the compartment floor). The gauge must be capable of easy insertion and removal; and while inserted, allow for the door(s) to be completely closed without interference.

**4.3 Operational Requirements**—The carrier access (Arrow lock) door, customer doors, parcel doors, master loading door(s), and hold open device(s) must be capable of operating 10,000 normal operating cycles (1 cycle = open/close) at room temperature, continuously and correctly, without any failures such as breakage of parts. The cycle rate for carrier access (Arrow lock), customer and parcel doors shall

not exceed 3 seconds per cycle. The cycle rate for the master loading door(s) and hold open device(s) shall not exceed 10 seconds per cycle. Testing may be performed either manually or by means of an automated, mechanically driven test fixture that replicates a manual operation.

**4.4 Water-Tightness**—A rain test in accordance with UL 771, section 47.7 shall be performed to determine a receptacle's ability to protect mail from water. Prior to the test, the unit shall be prepared by shielding the body of the receptacle so that only the master door, customer doors, and front frame elements shall be directly exposed to rain during the test. The rain test shall be operated for a period of 15 minutes on the customer compartment door (front) side of the mail receptacle. At the conclusion of the test, the outside of the unit is wiped dry and all doors are opened. The inside of the compartments must contain no water other than that produced by high moisture condensation.

**4.5 Salt Fog Resistance**—A salt fog test shall be conducted in accordance with method A5 of ASTM G85, Standard Practice for Modified Salt Spray (Fog) Testing. The salt test shall be operated for 25 continuous cycles with each cycle consisting of 1-hour fog and 1-hour dry-off. The unit shall be tested in a finished condition, including all protective coating, paint, and mounting hardware and shall be thoroughly washed when submitted to remove all oil, grease, and other nonpermanent coatings. No part of the receptacle may show finish corrosion, blistering, or peeling, or other destructive reaction upon conclusion of test. Corrosion is defined as any form of property change such as rust, oxidation, color changes, perforation, accelerated erosion, or disintegration. The buildup of salt deposits upon the surface shall not be cause for rejection. However, any corrosion, paint blistering, or paint peeling is cause for rejection. It is also valid for units made of plastic that employ metal hardware.

**4.6 Abrasion Resistance**—The unit's coating/finish shall be tested for resistance to abrasion in accordance with method A of ASTM D968. The rate of sand flow shall be 2 liters of sand in 22±3 seconds. The receptacle will have failed the sand abrasion test if less than 15 liters of sand penetrates its coating or if less than 75 liters of sand penetrates its plating. This test is applicable to metal receptacle designs only.

**4.7 Temperature Stress Test**—The unit under test shall be placed in a cold chamber at -40° Fahrenheit (F) for 24 hours. The chamber shall first be

stabilized at the test temperature. After remaining in the  $-40^{\circ}\text{F}$  environment for the 24-hour period, the unit shall be quickly removed from the cold chamber into room ambient and tested for normal operation. The removal from the chamber and the testing for normal operation shall be accomplished in less than 3 minutes. The room ambient shall be between  $65^{\circ}$  and  $75^{\circ}\text{F}$ . Normal operation is defined as operation

required and defined by this document. The unit under test shall undergo a similar temperature test, as described above, at a temperature of  $140^{\circ}\text{F}$ .

**4.8 Structural Rigidity Requirements**—Pull loads of the specified magnitudes (see table II) shall be slowly applied at any point of the specific item of the unit under test. These forces shall be held for a time not to exceed one minute and then released.

Supplemental bracing may be used to isolate the loading on the specific item to be tested. After the release of the load, the permanent deformation caused by the forces shall be measured. If the deformation exceeds the limit specified in table II, the unit under test has failed to meet the structural rigidity requirement.

TABLE II  
[Pull load permanent deformation limits]

Item	Permanent deformation (inches)	Pull load (pounds)
Carrier Access (Arrow Lock) Door(Front-Loading Designs) .....	1/8	1400
Collection Comp. Front Blanking Plate(Rear-Loading Designs) .....	1/8	1400
Collection Mail Slot Frame(All Designs Except Parcel-Only) .....	1/8	1400
Master Door(s) at Hinge Side—Top & Bottom (Front-Loading Designs) .....	1/8	1000
Master Door at Center Along Arrow Lock Side—(Front-Loading Designs) .....	1/8	1000
Rear Cover(Rear-Loading Designs) .....	1/8	250
Customer Compartment Door(All Designs Except Parcel-Only) .....	1/8	250
Parcel Compartment Door (All Designs Except Non-Parcel Versions) .....	1/8	250
Master Door Hold-Open Device(Front-Loading Designs) .....	0	50

**4.9 Impact Test**—The front exposed surfaces of the receptacles and any coatings applied to them shall not be cracked, chipped, broken, dented (more than  $1/16$  inch in depth), or visibly permanently deformed by a hard steel 2-pound ball with a  $1/2$ -inch spherical radius dropped from a height of 6 inches.

**4.10 Flammability**—A flammability test shall be conducted on all potentially flammable materials used in the unit. The test shall be conducted in accordance with ASTM D3801. The ASTM D3801 standard flame test shall achieve a rating of V-1 or better. (Note: It is the building owner's responsibility to make sure that the installation of any receptacle is in compliance with local building and fire codes.)

**4.11 Security Test**—Receptacles shall be tested, as described below, for resistance to tampering and unauthorized entry through the use of tools such as screwdrivers, flat plates, knives, pry bars, vise grips, pliers, chisels, and punches for a period not to exceed 3 minutes for each feature tested. No pry tools shall exceed 18 inches in length. Because of the critical nature of the master-loading door and Arrow lock (outgoing mail) compartment, a hammer shall be used in tandem with the other tools during tests of these items. The head weight of any hammer used shall not exceed 3 pounds. In addition, the Arrow lock compartment door will also be subjected to a 2-minute torch test using commonly available microtorch kits.

**4.11.1 Customer Compartment and Parcel Compartment Customer Access Locks**—Customer lock plugs shall withstand a minimum of 70 pounds of force slowly applied inward. Load forces shall be applied to the key entrance side of the lock. The lock and door shall remain closed and locked after each test. In addition, the locks shall be tested using vise grips and other tools in an attempt to turn the lock with the customer or parcel door in the closed position. These tests shall not allow access to the customer or parcel compartment.

**4.11.2 Customer Compartment Doors**—Gaps and seams around the perimeter of the customer compartment doors shall be tested using pry tools listed in 4.11 for a period not to exceed 3 minutes to ensure that access to the compartment cannot be gained. The lock-mounting hole in the door shall be able to withstand 100 foot-pounds of torque applied in the plane of the door, preventing the lock from being turned in the door allowing unauthorized entry into the compartment.

**4.11.3 Parcel Compartment Door**—Gaps and seams around the perimeter of the parcel compartment door(s) shall be tested using pry tools listed in 4.11 for a period not to exceed 3 minutes to ensure that access to the compartment cannot be gained.

**4.11.4 Master Loading Door (Front-Loading Designs only)**—Seams around the perimeter of the master loading door(s) shall not allow access to the interior of the receptacle when tested

using pry tools listed in 4.11 for a period not to exceed 3 minutes. A 3-pound hammer shall be used for a time period not to exceed 1 minute in tandem with these other tools during the tests of the master-loading door(s).

**4.11.5 Arrow Lock Compartment Door (Front Loading Designs only)**—The Arrow lock compartment door shall be tested using the pry tools in 4.11 for a period not to exceed 3 minutes. A 3-pound hammer shall be used for a time period not to exceed 1 minute in tandem with these other tools during the tests of various features of the Arrow lock compartment. Seams and gaps around the perimeter of the Arrow lock compartment door and the structural integrity of the door itself shall not allow access to the receptacle under test conditions. In addition, the Arrow lock compartment door will also be subjected to a 2-minute torch test using commonly available microtorch kits. (Note: These tests shall not be performed on the same test door.)

**4.11.6 Outgoing Mail Slot**—The mail slot and security shield design shall be tested using the pry tools in 4.11 for a period not to exceed 3 minutes. A 3-pound hammer shall be used for a time period not to exceed 1 minute in tandem with these other tools during the tests of the seams and gaps around the perimeter of the mail slot. In addition, as part of the test, a pry bar not exceeding 18 inches in length shall be inserted into the mail slot in an attempt to gain access to deposited mail in the compartment.

4.11.7 *Outgoing Mail Compartment Front Blanking Plate*—Gaps and seams around the perimeter of any outgoing mail compartment front blanking plate shall be tested using pry tools listed in 4.11 for a period not to exceed 3 minutes to ensure that access to the compartment cannot be gained. A 3-pound hammer shall be used for a time period not to exceed 1 minute in tandem with these other tools during the tests of the seams and gaps around the perimeter of this item.

4.11.8 *Rear Door/Panel (Rear Loading Designs only)*—The rear cover shall be tested for a period not to exceed 3 minutes by attempting to force it to unseat. No access to the backside of the unit or to any adjacent compartments shall be gained as a result of this test. All customer compartment and parcel locker doors shall be open for this test.

4.11.9 *Receptacle Installation (All Designs)*—Receptacles will be installed in a representative wall fixture in accordance with the installation instructions provided by the manufacturer. The receptacle's mounting hardware will be subjected to a uniform pull load of 500 pounds. This load will be applied by placing a bolster plate to the backside area of the receptacle and attaching it to one or more cables that are passed through drill holes added to the rear wall of the actual receptacle. Any front doors of customer compartments in alignment with the cables may be opened or removed for the test. All bolster plate cables will be tied together at a minimum distance of 3 feet from the front surface of the unit with a single cable fitted with a shackle, hook, etc. A maximum horizontal pull load of 500 pounds will be applied and the receptacle will have met this requirement if its mounting hardware is not loosened from its wall mount. Supplemental bracing of the wall may be used to isolate the loading on the receptacle's mounting hardware.

## 5. Quality Management System Provisions

5.1 *Quality System*—The approved source shall ensure and be able to substantiate that manufactured units conform to requirements and match the approved design.

5.2 *Inspection*—The USPS reserves the right to inspect units for conformance at any stage of manufacture. Inspection by the USPS does not relieve the approved source of the responsibility to provide conforming product. The USPS may, at its discretion, revoke the approval status of any product that does not meet the requirements of this standard.

5.3 *System*—The approved source shall use a documented quality management system acceptable to the USPS. The USPS has the right to evaluate the acceptability and effectiveness of the approved source's quality management system prior to approval, and during tenure as an approved source. As a minimum, the quality management system shall include controls and record keeping in the following areas:

### 5.3.1 *Document Control*—

Documents used in the manufacture of product shall be controlled. The control process for documents shall ensure the following:

- Documents are identified, reviewed, and approved prior to use,
- Revision status is identified,
- Documents of external origin are identified and controlled.

5.3.2 *Supplier Oversight*—A documented process that ensures the following:

- Material requirements and specifications are clearly described in procurement documents,
- Inspection or other verification methods are established and implemented for validation of purchased materials.

5.3.3 *Inspection and Testing*—The approved source shall monitor and verify that product characteristics match approved design. This activity shall be carried out at appropriate stages of manufacture to ensure that only acceptable products are delivered.

5.3.4 *Control of Nonconforming Product*—The control method and disposition process shall be defined and ensure that any product or material that does not conform to the approved design is identified and controlled to prevent its unintended use or delivery.

5.3.5 *Control of Inspection, Measuring, and Test Equipment*—The approved source shall ensure that all equipment used to verify product conformance is controlled, identified, and calibrated at prescribed intervals traceable to nationally recognized standards in accordance with documented procedures.

5.3.6 *Corrective Action*—The approved source shall maintain a documented complaint process. This process shall ensure that all complaints are reviewed and that appropriate action is taken to determine cause and prevent reoccurrence. Action shall be taken in a timely manner and be based on the severity of the nonconformance.

**Note:** It is recognized that each approved source functions individually and consequently, the quality system of each approved source may differ in the specific

methods of accomplishment. It is not the intent of this standard to attempt to standardize these systems, but to present the basic functional concepts that when conscientiously implemented will provide assurance that the approved source's product meets the requirements and fully matches the approved design.

In addition to outlining the approved source's approach to quality, the documentation should specify the methodology used to accomplish the interlinked processes and describe how they are controlled. The approved source shall submit its quality documentation to the Postal Service for review along with the preliminary design review.

5.3.7 *Documentation Retention*—All of the approved source's documentation pertaining to the approved product shall be kept for a minimum of three (3) years after shipment of product.

5.3.8 *Documentation Submittal*—The approved source shall submit a copy of their quality system documentation relevant to the manufacture of wall-mounted, centralized mail receptacles for review as requested during the approval process and tenure as an approved source.

## 6. Application Requirements

6.1 *Application Requirements*—All correspondence and inquiries shall be directed to the address in 1.3. The application process consists of:

6.1.1 *Preliminary Review*—Manufacturers must first satisfy requirements of a preliminary review prior to submitting samples of any receptacles. The preliminary review consists of a review of the manufacturer's conceptual design drawings for each receptacle type for which the manufacturer is seeking approval. Computer-generated drawings are preferred, but hand-drawn sketches are acceptable provided they adequately depict the important design aspects of the proposed receptacle design. In particular, drawings should include overall unit with standard and optional compartment size information plus details on the design of such critical features as the carrier access, customer, parcel and master load door(s) designs, hinge designs, all lock-mounting techniques and cam engagements, material selections, the 3-point latching and handle designs, the wall mounting concept, and outgoing mail slot design. If drawings show that the proposed receptacle design appears likely to comply with the requirements of this standard, manufacturers will be notified in writing and may then continue with the application requirements described

in 6.1.2. Do NOT submit any sample units to the USPS prior to complying with the requirements of 6.1.2. Notification that a manufacturer's drawings satisfy the requirements of the preliminary review does NOT constitute USPS approval of a design, and shall NOT be relied upon as an assurance that a design will ultimately be approved.

**6.1.2 Independent Lab Testing**—Upon receiving written notification from the USPS that their design(s) satisfies requirements of the preliminary review, manufacturers shall at their own expense submit at least one representative sample of the highest total-compartment version of each Type apartment receptacle for which the vendor seeks USPS approval to an independent laboratory for testing along with a copy of the preliminary review letter from the USPS. If the vendor plans to offer optional compartment sizes, the submitted samples shall include at least one of the largest compartment size. All tests shall be performed by an approved independent test lab, except for the security tests which shall be performed by the Postal Service. See Appendix A for a list of USPS approved independent test labs.

**6.1.3 Final Review**—Manufacturers shall submit two representative samples of the largest (typically, the highest

total-compartment) version to the USPS for security testing, final review and approval. If the vendor plans to offer optional compartment sizes, the submitted samples shall include at least one of the largest compartment size. The sample shall be accompanied with a certificate of compliance and a copy of the laboratory test results (see 6.1.3.3). Receptacles submitted to the USPS (see 1.3) for final evaluation must be identical in every way to the receptacles to be marketed, and must be marked as specified in 3.11. Manufacturers may be subject to a verification of their quality system prior to approval. This may consist of a review of the manufacturer's quality manual (see 6.1.3.4) and an onsite quality system evaluation (see 5.2).

**6.1.3.1 Installation Instructions**—Manufacturers shall furnish a written copy of their installation instructions for review. These instructions shall contain all information as detailed in section 3.13.

**6.1.3.2 Documentation**—Units submitted for approval shall be accompanied by two complete sets of manufacturing drawings consisting of black on white prints (blueprints or sepia are unacceptable). The drawings shall be dated and signed by a manufacturer's representative(s). The

drawings must completely document and represent the design of the unit tested. If other versions of the approved Type unit are to be offered, the drawings must include the unique or differing design items of these versions. The drawings must include sufficient details to allow the USPS to inspect all materials, construction methods, processes, coatings, treatments, finishes (including paint types), control specifications, parts, and assemblies used in the construction of the unit. Additionally, the drawings must fully describe any purchased materials, components, and hardware including their respective finishes. The USPS may request individual piece parts to verify drawings.

**6.1.3.3 Certification of Compliance & Test Results**—Manufacturers shall furnish a written certificate of compliance indicating that their design fully complies with the requirements of this standard. In addition, the manufacturer shall submit the lab's original report which clearly shows results of each test conducted (see table IV). The manufacturer bears all responsibility for their unit(s) meeting these requirements and the USPS reserves the right to retest any and all units submitted including those which are available to the general public.

TABLE IV.—TEST REQUIREMENTS

Test	Requirement	Reference	Industry specifications
Capacity .....	Insertion of test gauges .....	4.2	
Operational Requirements .....	10,000 cycles .....	4.3	
Water-Tightness .....	No appreciable moisture .....	4.4	UL 771, section 47.7.
Salt Fog Resistance .....	25 cycles .....	4.5	ASTM G85.
Abrasion Resistance .....	75 liters .....	4.6	ASTM D968.
Temperature Stress Test .....	Shall function between -40°F and 140°F .....	4.7	
Structural Rigidity Requirements .....	Refer to Table I for loads and points, maximum 1/8 inch permanent deformation.	4.8	
Impact .....	2 lbs. dropped from 6 inches .....	4.9	
Flammability .....	V-1 or better .....		ASTM D 3801.

**6.1.3.4 Quality Policy Manual**—Manufacturer shall submit its quality policy manual to the address listed in section 1.3.

**7. Approval or Disapproval**

**7.1 Disapproval**—Written notification, including reasons for disapproval, will be sent to the manufacturer within 30 days of completion of the final review of all submitted units. All correspondence and inquiries shall be directed to the address listed in 1.3.

**7.1.1 Disapproved Receptacles**—Units disapproved will be disposed of in 30 calendar days from the date of the

written notification of disapproval or returned to the manufacturer, if requested, provided the manufacturer pays shipping costs.

**7.2 Approval**—One set of manufacturing drawings with written notification of approval will be returned to the manufacturer. The drawings will be stamped and identified as representing each unit.

**7.2.1 Approved Receptacles**—Units that are approved will be retained by the USPS.

**7.2.2 Rescission**—Manufacturer's production units shall be constructed in accordance with the USPS-certified drawings and the provisions of this

specification and be of the same materials, construction, coating, workmanship, finish, etc., as the approved units. The USPS reserves the right at any time to examine and retest units obtained either in the general marketplace or from the manufacturer. If the USPS determines that a receptacle model is not in compliance with this standard or is out of conformance with approved drawings, the USPS may, at its discretion, rescind approval of the receptacle as follows:

**7.2.2.1 Written Notification**—The USPS shall provide written notification to the manufacturer that a receptacle is not in compliance with this standard or

is out of conformance with approved drawings. This notification shall include the specific reasons that the unit is noncompliant or out of conformance and shall be sent via Registered Mail™.

**7.2.2.1.1 Health and Safety**—If the USPS determines that the noncompliance or nonconformity constitutes a danger to the health or safety of customers and/or letter carriers, the USPS may, at its discretion, immediately rescind approval of the unit. In addition, the USPS may, at its discretion, order that production of the receptacle cease immediately, and that any existing inventory not be sold for receipt of U.S. mail.

**7.2.2.2 Manufacturer's Response**—In all cases of noncompliance or nonconformity other than those determined to constitute a danger to the health or safety of customers and/or letter carriers, the manufacturer shall confer with the USPS and shall submit one sample of a corrected receptacle to the USPS for approval no later than 45 calendar days after receipt of the notification described in 7.2.2.1. Failure to confer or submit a corrected receptacle within the prescribed period shall constitute grounds for immediate rescission.

**7.2.2.3 Second Written Notification**—The USPS shall respond to the manufacturer in writing, via Registered Mail™, no later than 30

calendar days after receipt of the corrected receptacle with a determination of whether the manufacturer's submission is accepted or rejected and with specific reasons for the determination.

**7.2.2.4 Manufacturer's Second Response**—If the USPS rejects the corrected receptacle, the manufacturer may submit a second sample of the corrected receptacle to the USPS for approval no later than 45 calendar days after receipt of the notification described in 7.2.2.3. Failure to confer or submit a corrected receptacle within the prescribed period shall constitute grounds for immediate rescission.

**7.2.2.5 Final USPS Rescission Notification**—The USPS shall provide a final response to the manufacturer in writing no later than 30 calendar days after receipt of the second sample corrected receptacle with a determination of whether the manufacturer's submission is accepted or rejected and with specific reasons for the determination. If the second submission is rejected, the USPS may, at its discretion, rescind approval of the receptacle. In addition, the USPS may, at its discretion, order that production of the receptacle cease immediately, and that any existing inventory not be sold or used for receipt of U.S. mail. If the USPS rescinds approval, the manufacturer is not prohibited from

applying for a new approval pursuant to the provisions of section 6.

**7.2.3 Revisions, Product or Drawings**—Changes that affect the form, fit, and/or function (*i.e.*, dimensions, material, finish, etc.) of approved products or drawings shall not be made without written USPS approval. Any proposed changes shall be submitted with the affected documentation reflecting the changes (including a notation in the revision area), and a written explanation of the changes. One unit, incorporating the changes, may be required to be resubmitted for testing and evaluation for approval.

**7.2.3.1 Corporate or Organizational Changes**—If any substantive part of the approved manufacturer's structure changes from what existed when the manufacturer became approved, the manufacturer shall promptly notify the USPS and will be subject to a reevaluation of their approved product(s) and/or quality system. Examples of substantive structural changes include the following: change in ownership, executive or quality management; major change in quality policy or procedures; relocation of manufacturing facilities; major equipment or manufacturing process change (*e.g.*, outsourcing vs. inplant fabrication); etc. Notification of such changes must be sent to the address in section 1.3.

**BILLING CODE 7710-12-P**

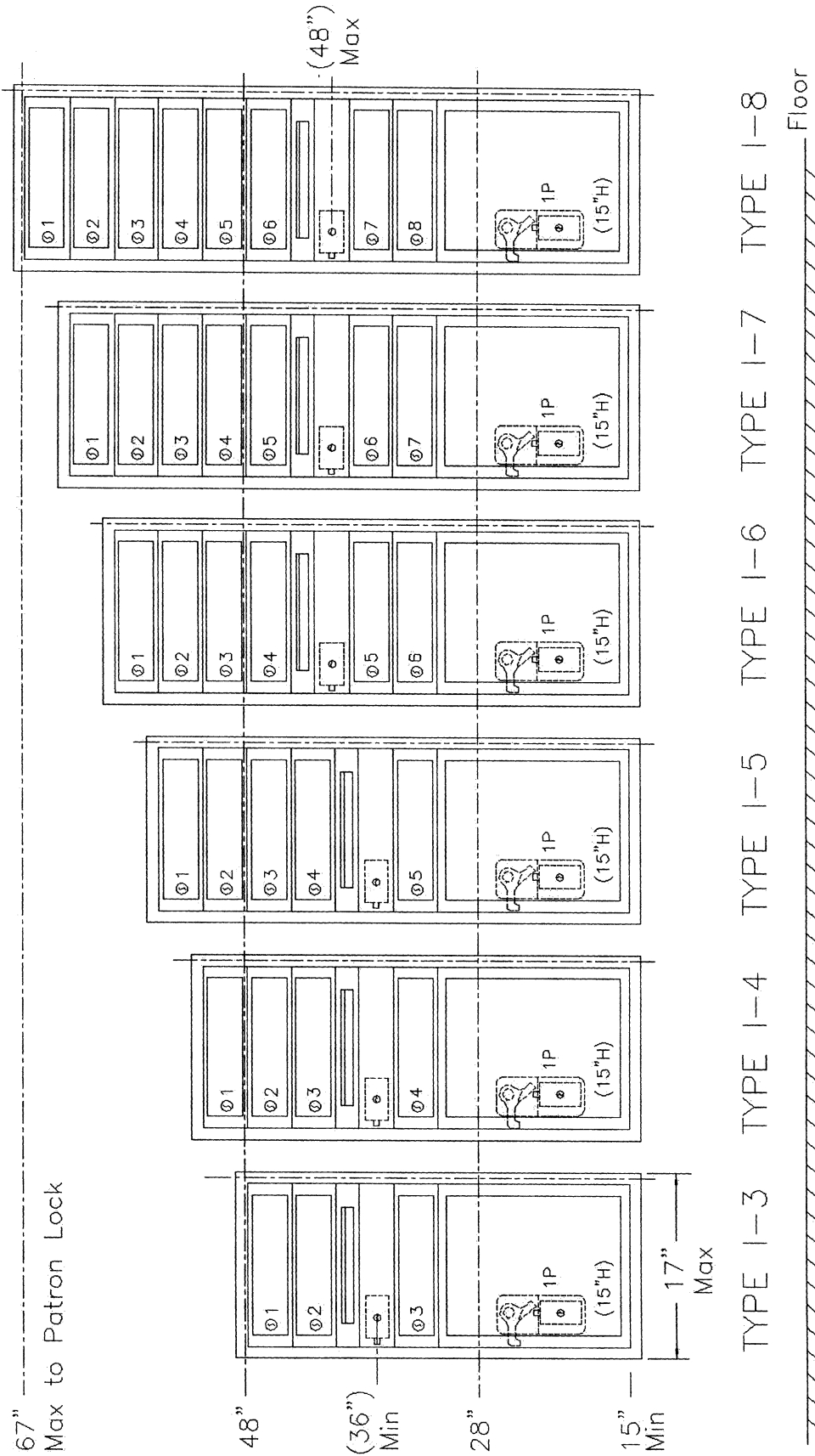

Notes - All units shall be designed such that they are in compliance with the following installation requirements:

1. At least one customer compartment shall be positioned less than 48 inches from the finished floor.
2. No parcel locker compartment (interior bottom shelf) shall be positioned less than 15 inches from the finished floor.
3. No patron lock shall be located more than 67 inches above the finished floor.
4. No customer compartment (interior bottom shelf) shall be positioned less than 28 inches from the finished floor.
5. The USPS Arrow lock shall be located between 36 and 48 inches above the finished floor.

**Figure 1 - Front Loader**

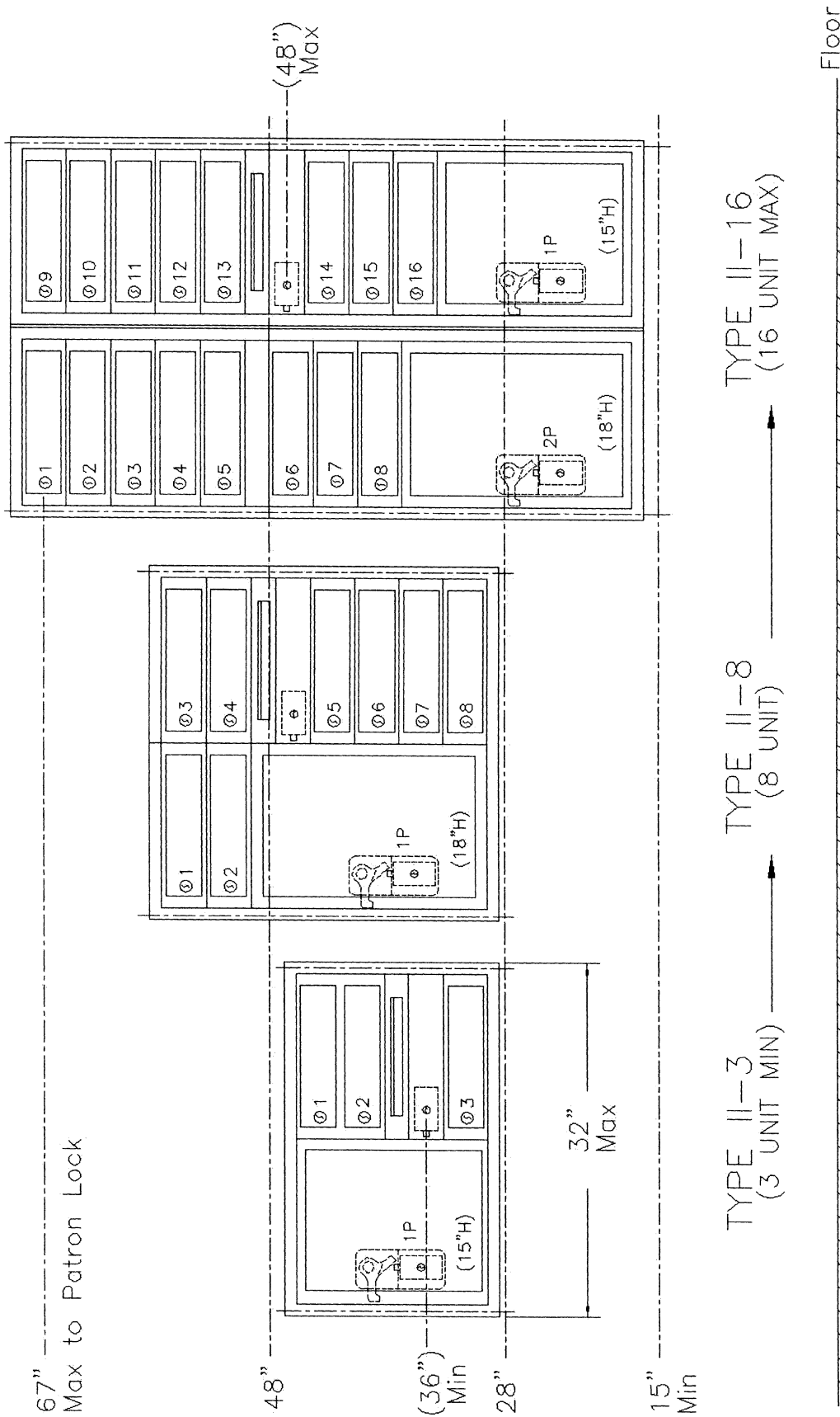

- Notes - All units shall be designed such that they are in compliance with the following installation requirements:
1. At least one customer compartment shall be positioned less than 48 inches from the finished floor.
  2. No parcel locker compartment (interior bottom shelf) shall be positioned less than 15 inches from the finished floor.
  3. No patron lock shall be located more than 67 inches above the finished floor.
  4. No customer compartment (interior bottom shelf) shall be positioned less than 28 inches from the finished floor.
  5. The USPS Arrow lock shall be located between 36 and 48 inches above the finished floor.

Figure 2 - Front Loader, Double Column & Master Door

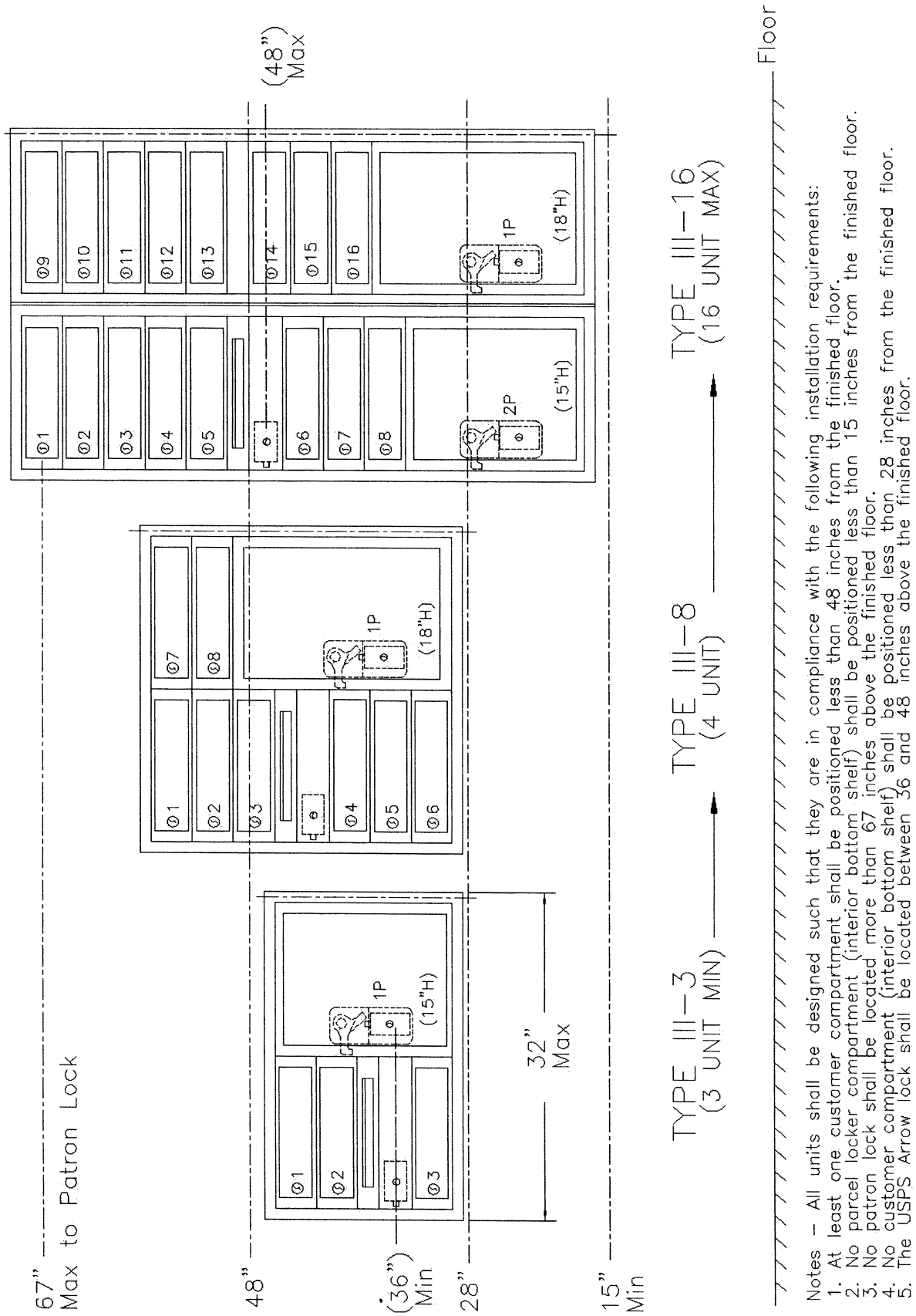

- Notes - All units shall be designed such that they are in compliance with the following installation requirements:
1. At least one customer compartment shall be positioned less than 48 inches from the finished floor.
  2. No parcel locker compartment (interior bottom shelf) shall be positioned less than 15 inches from the finished floor.
  3. No patron lock shall be located more than 67 inches above the finished floor.
  4. No customer compartment (interior bottom shelf) shall be positioned less than 28 inches from the finished floor.
  5. The USPS Arrow lock shall be located between 36 and 48 inches above the finished floor.

**Figure 3 - Front Loader, Double Column Single Master Door**



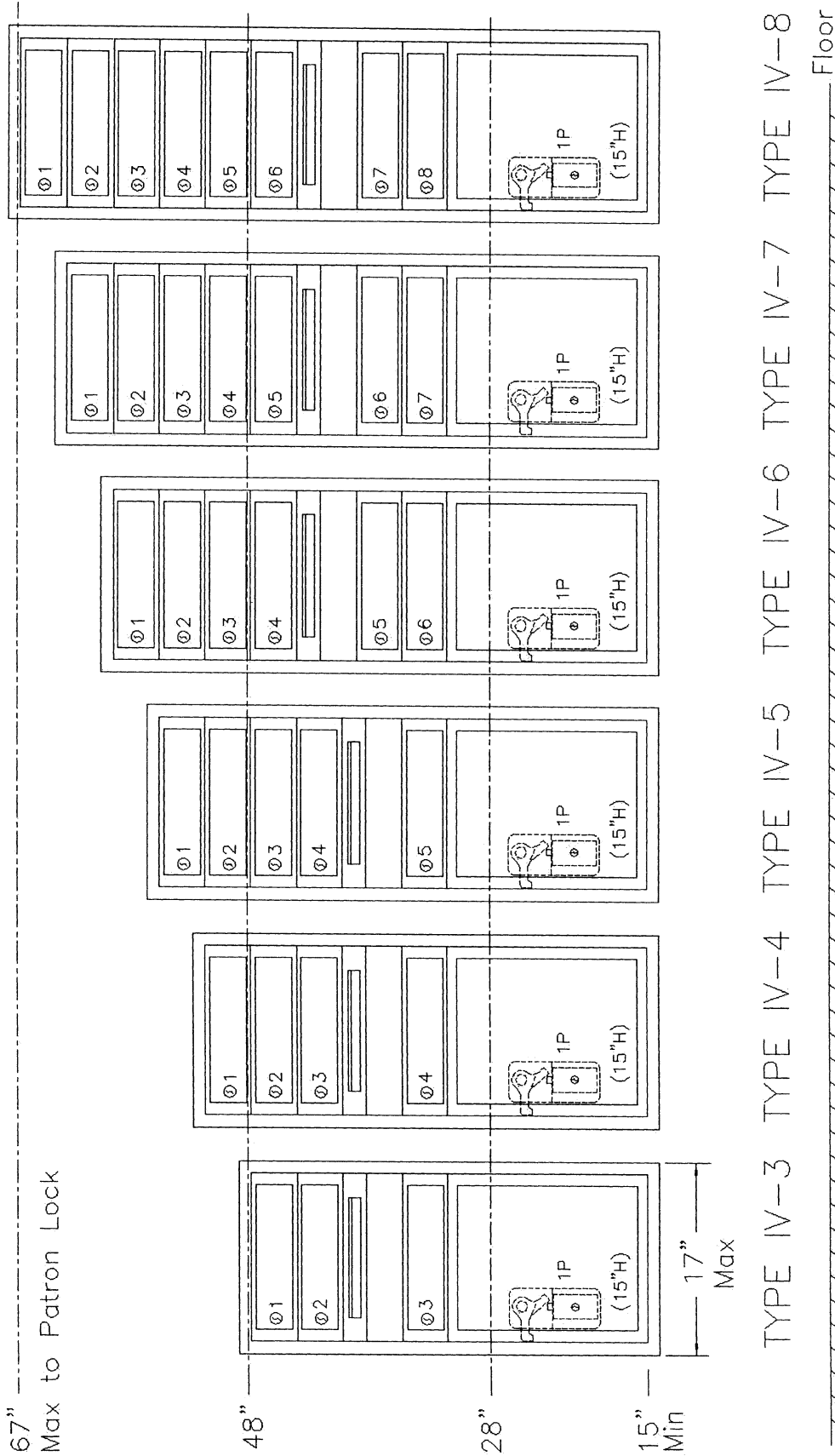

Notes - All units shall be designed such that they are in compliance with the following installation requirements:

1. At least one customer compartment shall be positioned less than 48 inches from the finished floor.
2. No parcel locker compartment (interior bottom shelf) shall be positioned less than 15 inches from the finished floor.
3. No patron lock shall be located more than 67 inches above the finished floor.
4. No customer compartment (interior bottom shelf) shall be positioned less than 28 inches from the finished floor.
5. The USPS Arrow lock shall be located between 36 and 48 inches above the finished floor.

**Figure 4 - Rear Loader, Single Column**

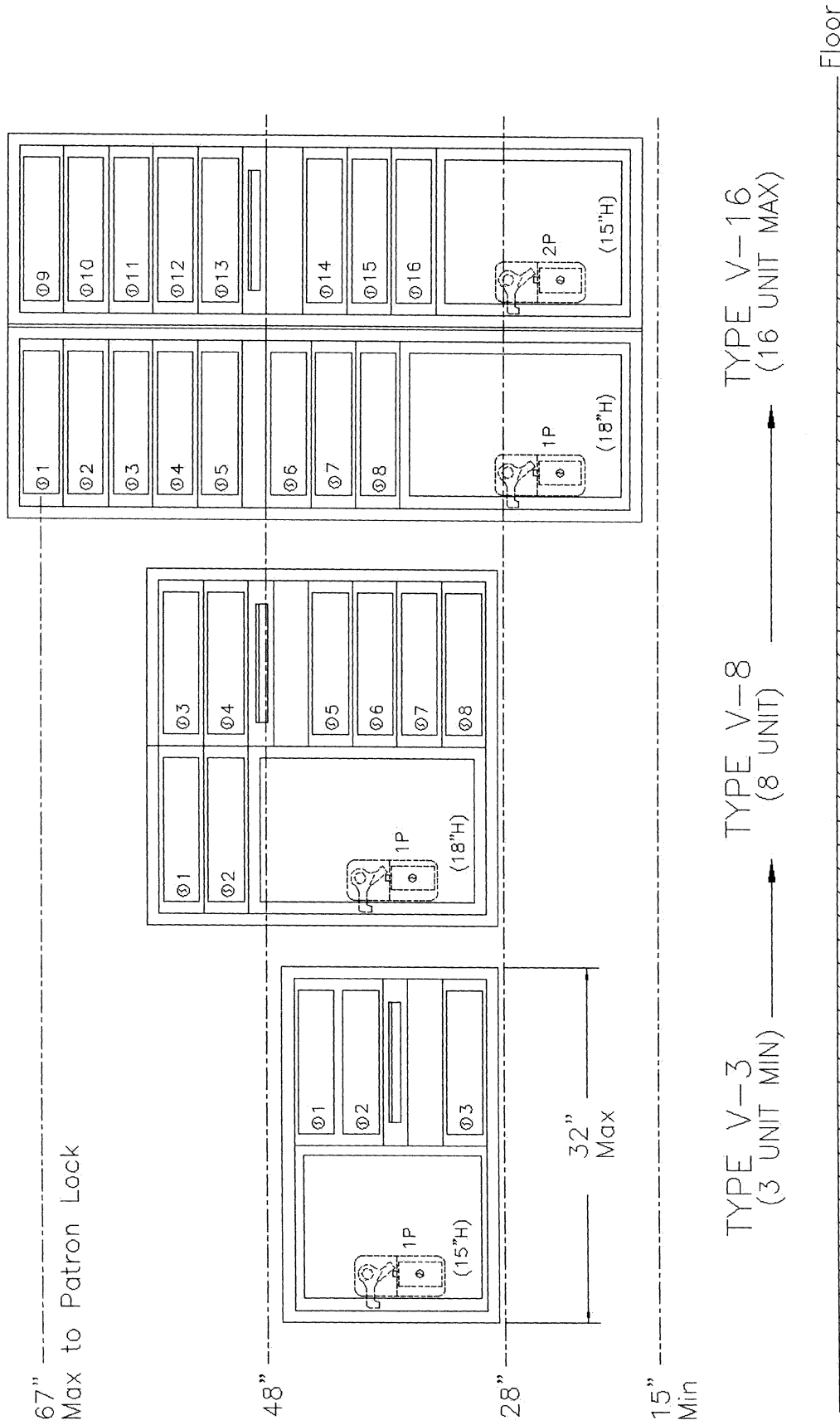

Notes - All units shall be designed such that they are in compliance with the following installation requirements:

1. At least one customer compartment shall be positioned less than 48 inches from the finished floor.
2. No parcel locker compartment (interior bottom shelf) shall be positioned less than 15 inches from the finished floor.
3. No patron lock shall be located more than 67 inches above the finished floor.
4. No customer compartment (interior bottom shelf) shall be positioned less than 28 inches from the finished floor.
5. The USPS Arrow lock shall be located between 36 and 48 inches above the finished floor.

**Figure 5 - Rear Loader, Double Column**

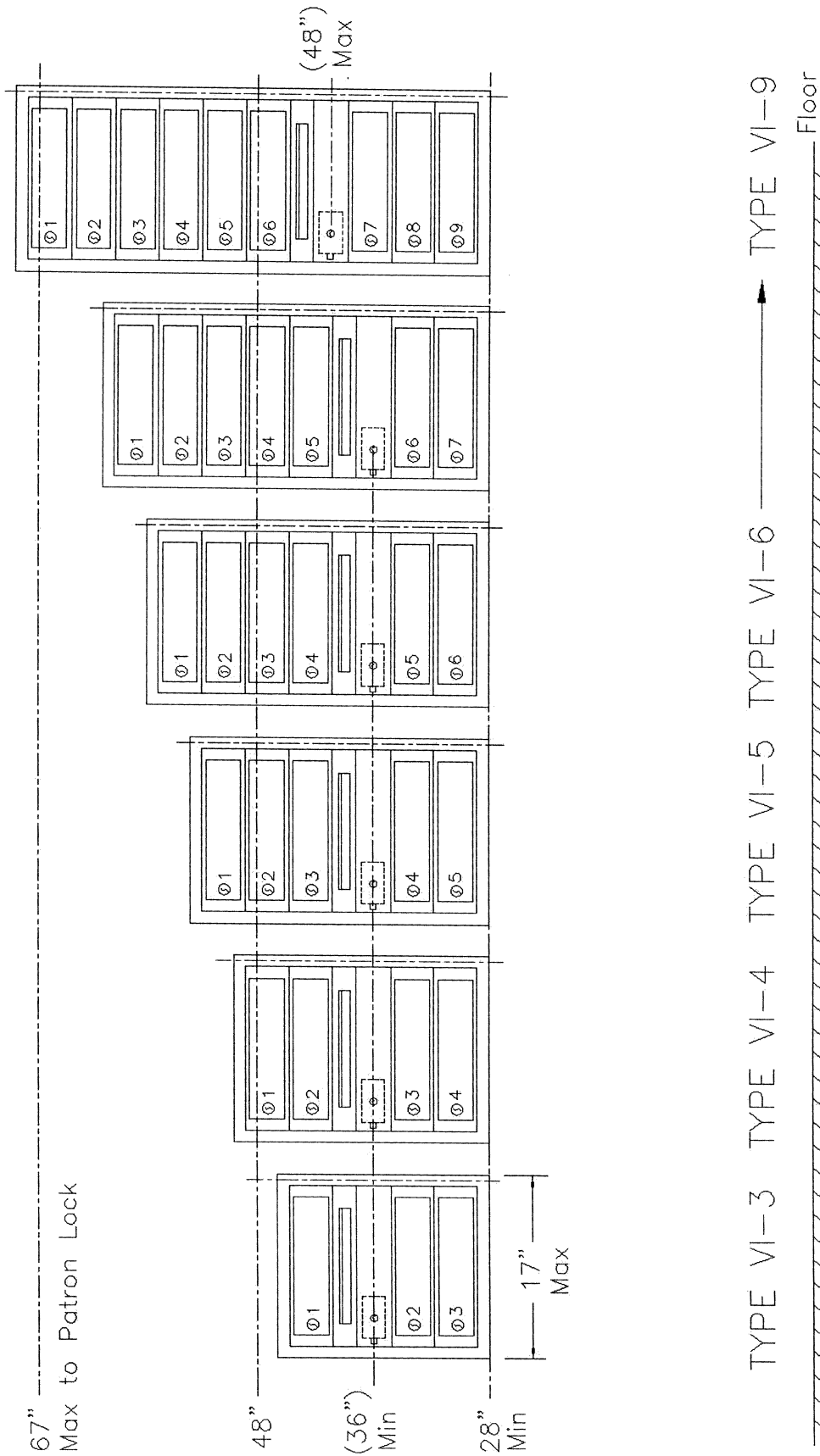

Notes - All units shall be designed such that they are in compliance with the following installation requirements:

1. At least one customer compartment shall be positioned less than 48 inches from the finished floor.
2. No parcel locker compartment (interior bottom shelf) shall be positioned less than 15 inches from the finished floor.
3. No patron lock shall be located more than 67 inches above the finished floor.
4. No customer compartment (interior bottom shelf) shall be positioned less than 28 inches from the finished floor.
5. The USPS Arrow lock shall be located between 36 and 48 inches above the finished floor.

Figure 6 - Front Loader, Single Column (No Parcel Compartment)

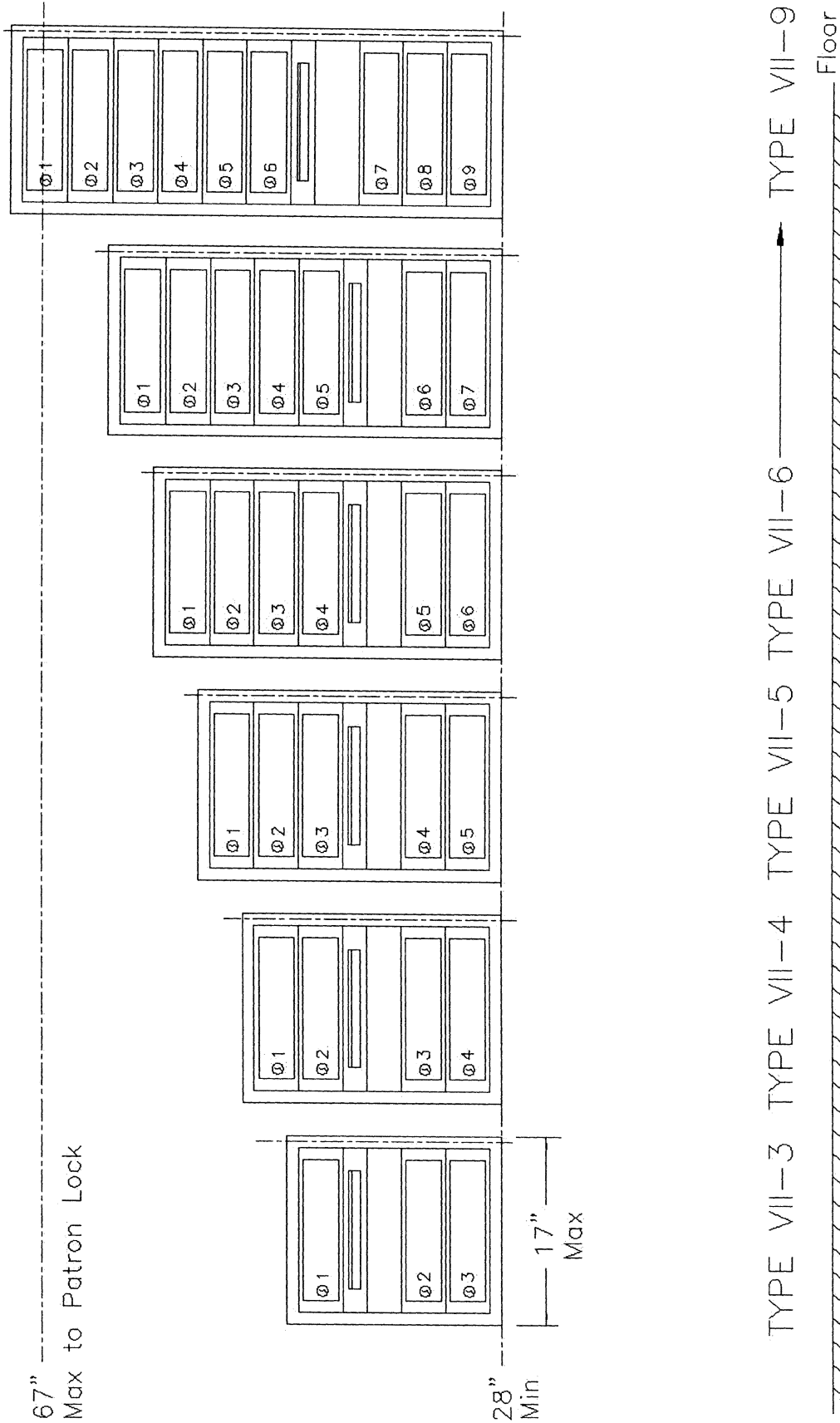

Notes - All units shall be designed such that they are in compliance with the following installation requirements:

1. At least one customer compartment shall be positioned less than 48 inches from the finished floor.
2. No parcel locker compartment (interior bottom shelf) shall be positioned less than 15 inches from the finished floor.
3. No patron lock shall be located more than 67 inches above the finished floor.
4. No customer compartment (interior bottom shelf) shall be positioned less than 28 inches from the finished floor.

**Figure 7 - Rear Loader, Single Column (No Parcel Compartment)**

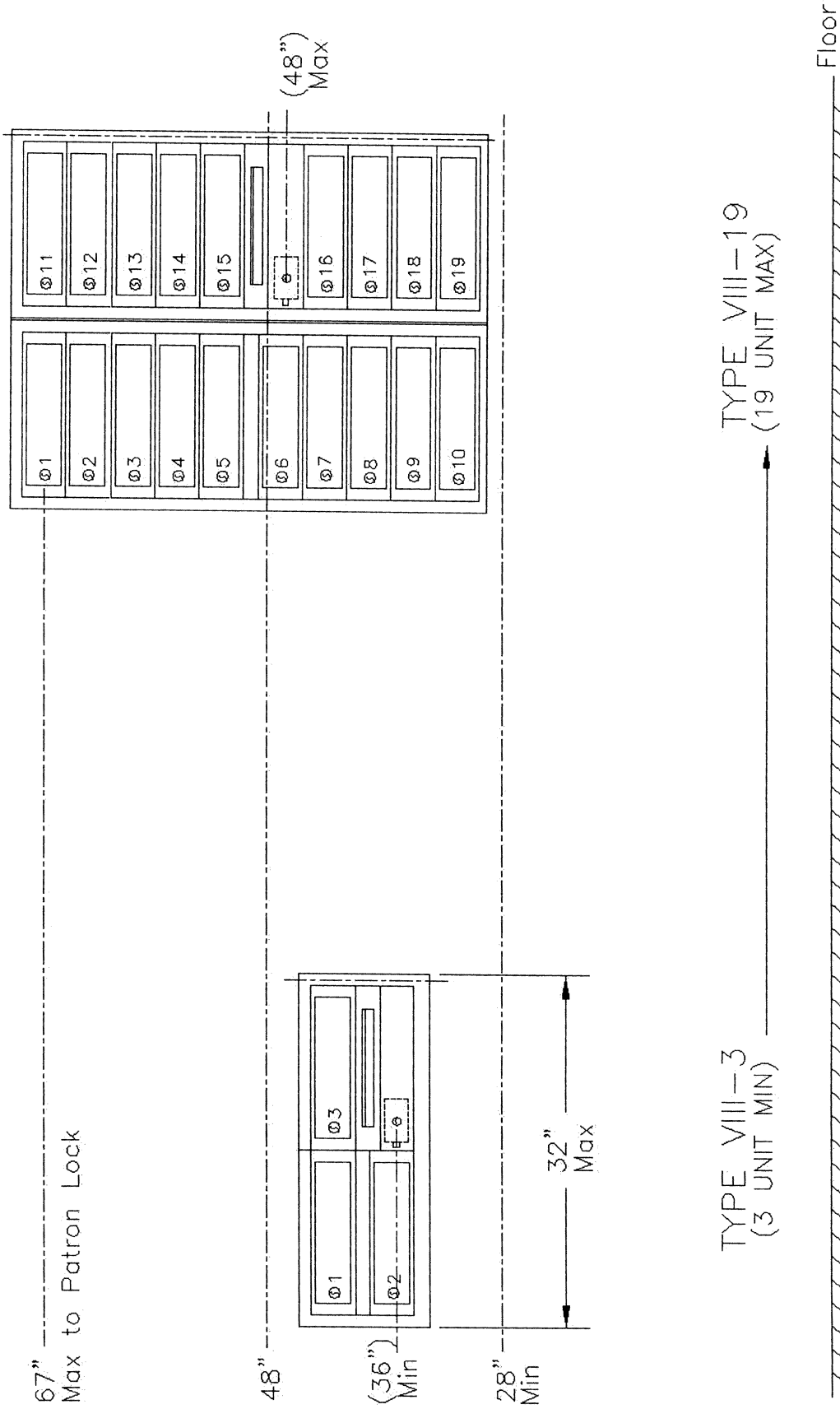

Notes - All units shall be designed such that they are in compliance with the following installation requirements:

1. At least one customer compartment shall be positioned less than 48 inches from the finished floor.
2. No parcel locker compartment (interior bottom shelf) shall be positioned less than 15 inches from the finished floor.
3. No patron lock shall be located more than 67 inches above the finished floor.
4. No customer compartment (interior bottom shelf) shall be positioned less than 28 inches from the finished floor.
5. The USPS Arrow lock shall be located between 36 and 48 inches above the finished floor.

**Figure 8 - Front Loader, Double Column & Master Door (No Parcel Compartment)**

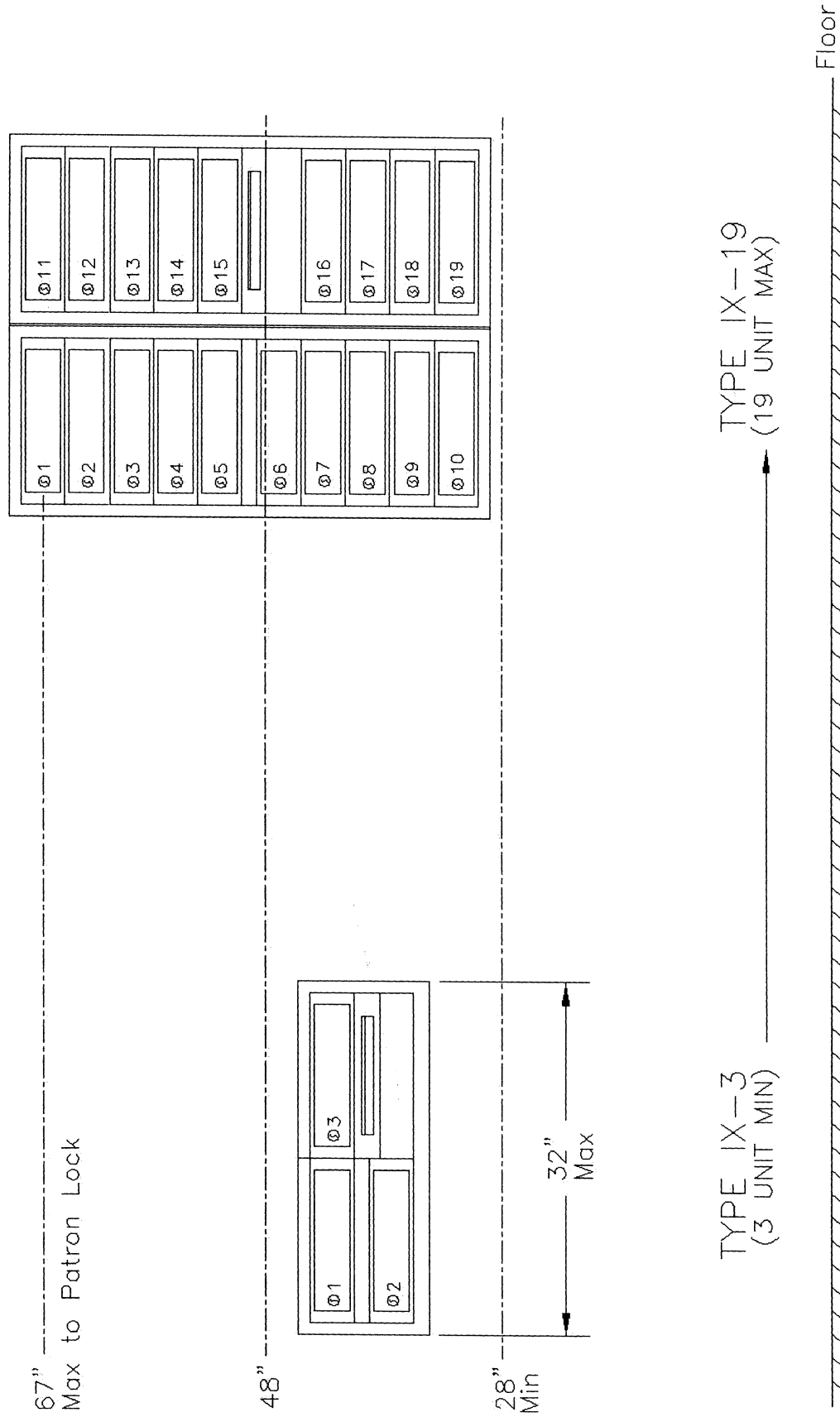

Notes - All units shall be designed such that they are in compliance with the following installation requirements:

1. At least one customer compartment shall be positioned less than 48 inches from the finished floor.
2. No parcel locker compartment (interior bottom shelf) shall be positioned less than 15 inches from the finished floor.
3. No patron lock shall be located more than 67 inches above the finished floor.
4. No customer compartment (interior bottom shelf) shall be positioned less than 28 inches from the finished floor.
5. The USPS Arrow lock shall be located between 36 and 48 inches above the finished floor.

**Figure 9 - Rear Loader, Double Column (No Parcel Compartment)**

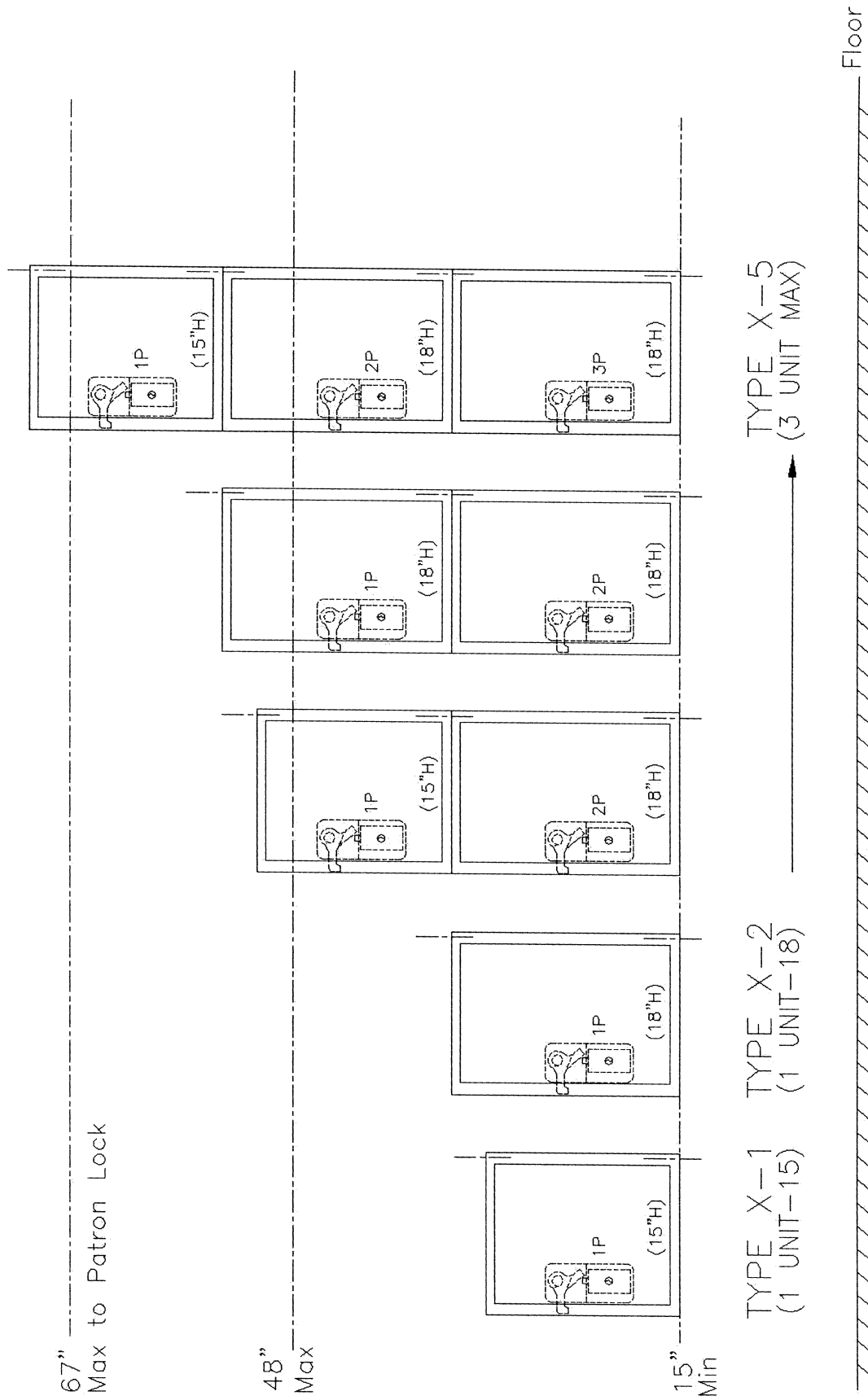

Notes - All units shall be designed such that they are in compliance with the following installation requirements:

1. No parcel locker compartment (interior bottom shelf) shall be positioned less than 15 inches from the finished floor.
2. No patron lock shall be located more than 67 inches above the finished floor.
3. The USPS Arrow lock shall be located between 36 and 48 inches above the finished floor.

**Figure 10 - Front Loader, Parcel Only (No Master Door)**

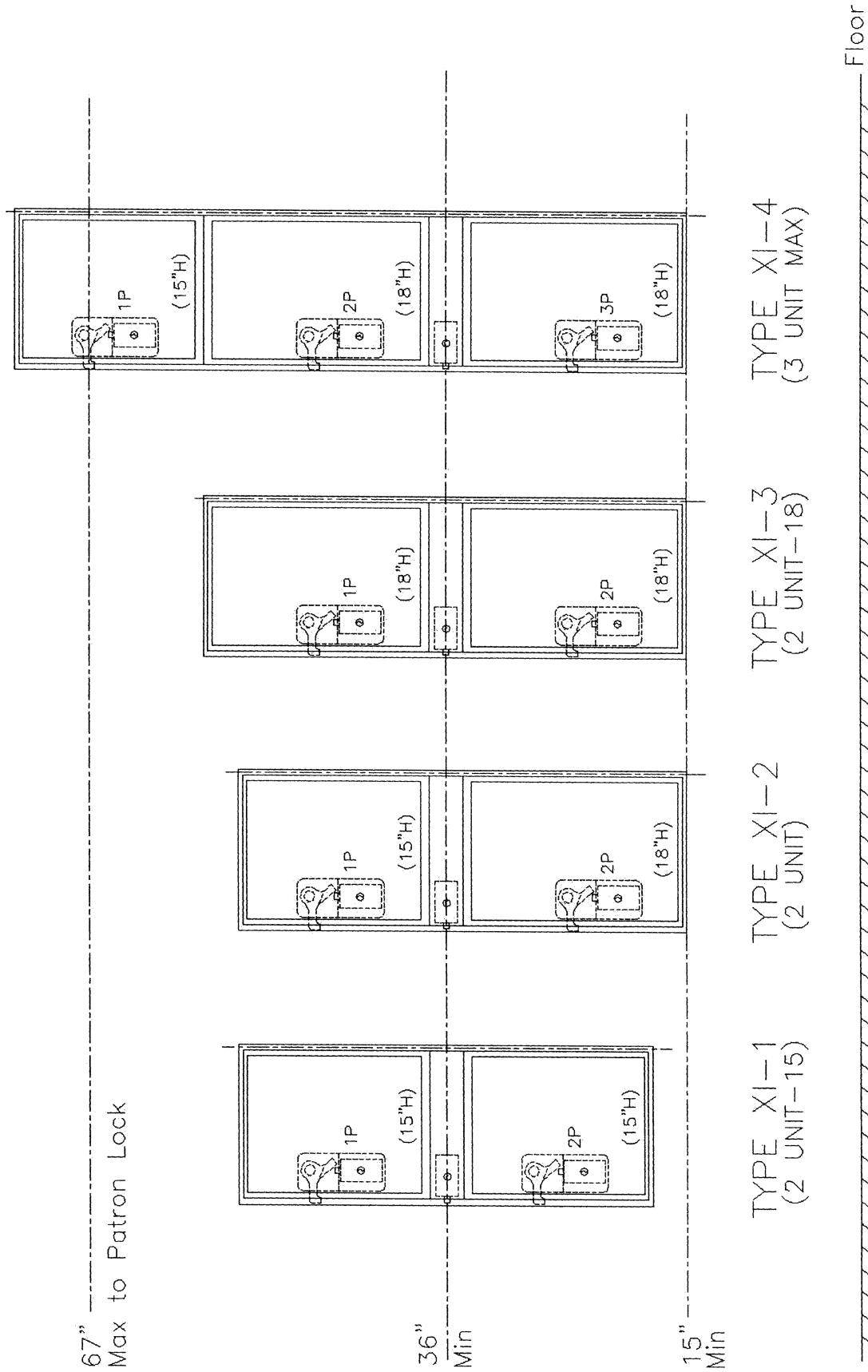

Notes - All units shall be designed such that they are in compliance with the following installation requirements:

1. No parcel locker compartment (interior bottom shelf) shall be positioned less than 15 inches from the finished floor.
2. No patron lock shall be located more than 67 inches above the finished floor.
3. The USPS Arrow lock shall be located between 36 and 48 inches above the finished floor.

**Figure 11 - Front Loader, Parcel Only (Master Door)**



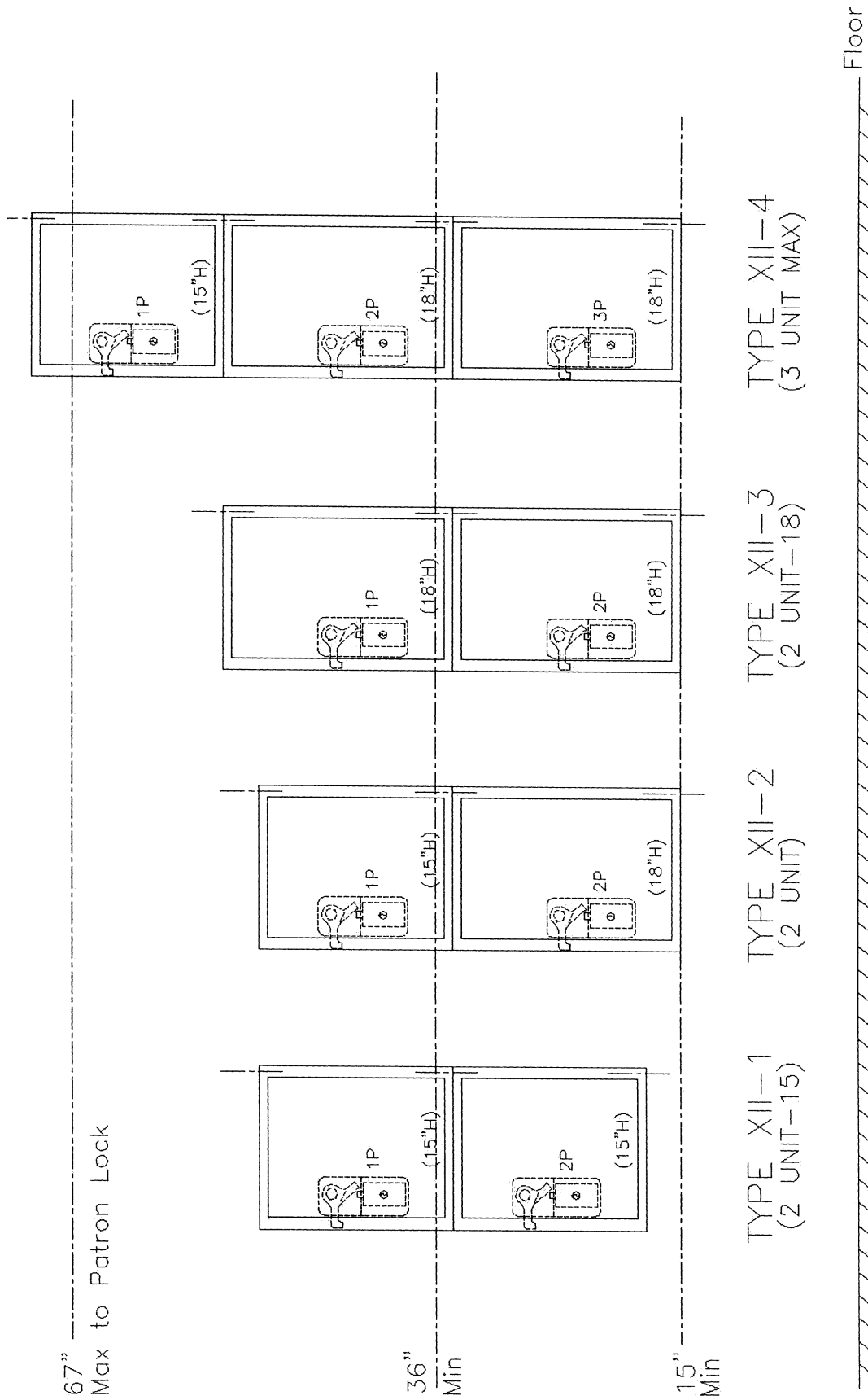

- Notes - All units shall be designed such that they are in compliance with the following installation requirements:
1. No parcel locker compartment (interior bottom shelf) shall be positioned less than 15 inches from the finished floor.
  2. No patron lock shall be located more than 67 inches above the finished floor.
  3. The USPS Arrow lock shall be located between 36 and 48 inches above the finished floor.

Figure 12 - Rear Loader, Parcel Only

**Figure 13. Arrow Lock Assembly**

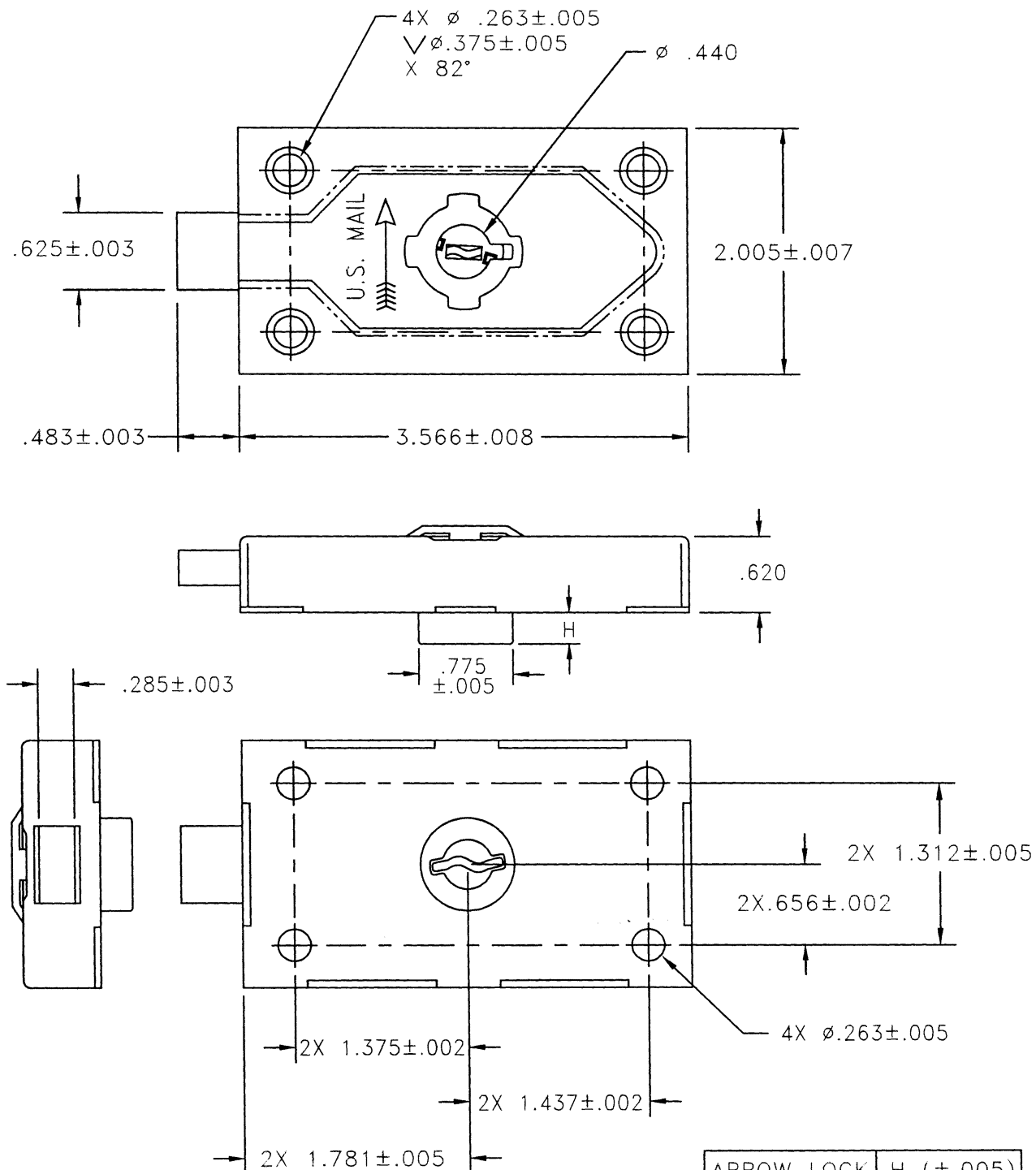

ARROW LOCK	H ( $\pm .005$ )
STANDARD	.275
MODIFIED	.375

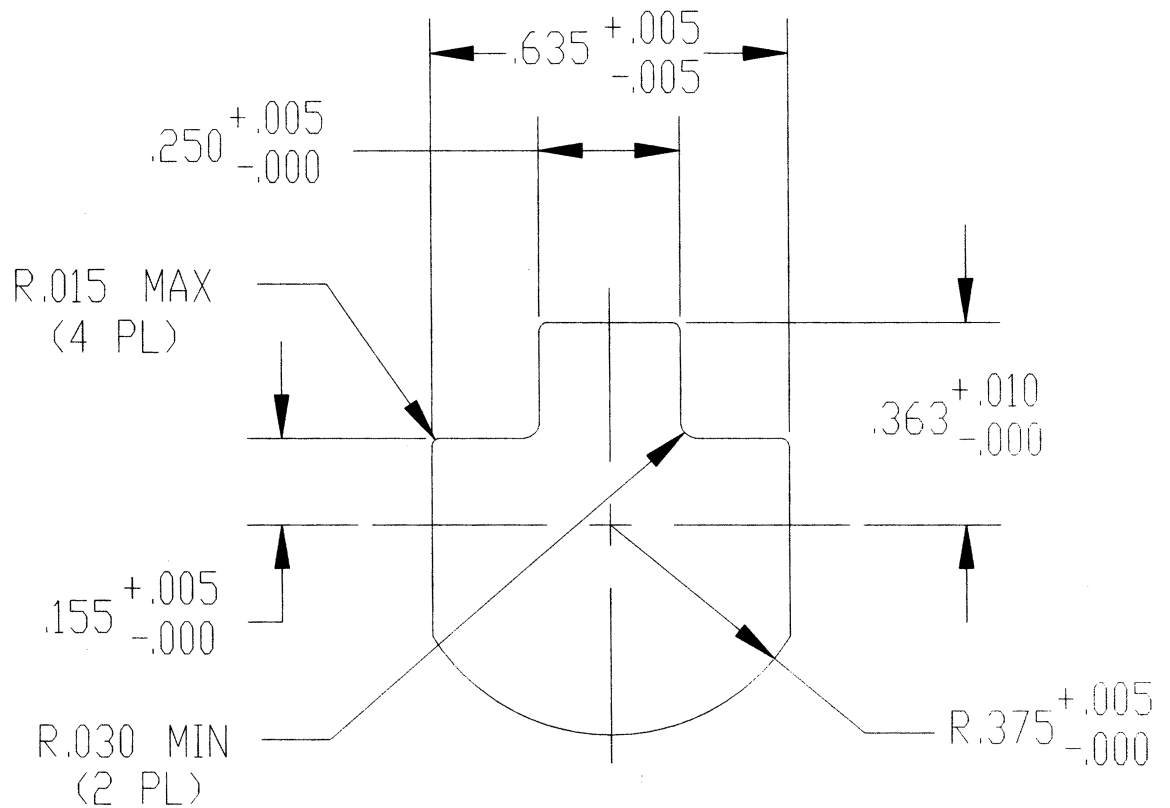

**Figure 14. Mounting Hole, PSIN 0910 Customer Lock**

BILLING CODE 7710-12-C

#### Appendix A

##### USPS Approved Independent Test Laboratories

(1) ACTS Test Labs, Contact: Dennis MacLaughlin, Phone: 716-505-3547 Fax: 716-505-3301, 100 Northpointe Parkway, Buffalo, NY 14228-1884.

(2) The Coatings Lab, Contact: Tom Schwerdt, Phone: 713-981-9368 Fax: 713-776-9634, 10175 Harwin Drive, Suite 110, Houston, TX 77036.

(3) Ithaca Materials Research & Testing, Inc. (IMR), Contact: Jeff Zerilli, Vice President, Phone: 607-533-7000, Lansing Business and Technology Park, 31 Woodsedge Drive, Lansing, NY 14882.

(4) Independent Test Laboratories, Inc., Contact: Robert Bouvier, Phone: 800-962-Test Fax: 714-641-3836, 1127B Baker Street, Costa Mesa, CA 92626.

(5) Midwest Testing Laboratories, Inc., Contact: Cherie Ulatowski, Phone: 248-689-9262, Fax: 248-689-7637, 1072 Wheaton, Troy, MI 48083.

**Note:** Additional test laboratories may be added provided they satisfy USPS

certification criteria. Interested laboratories should contact: USPS, Engineering, Test Evaluation & Quality, 8403 Lee Highway, Merrifield, VA 22082-8101.

The Postal Service will publish an appropriate amendment to 39 CFR 111.3 to reflect these changes.

**Stanley F. Mires,**

*Chief Counsel, Legislative.*

[FR Doc. 04-19781 Filed 9-2-04; 8:45 am]

BILLING CODE 7710-12-P